

Care & Use Manual



30-inch Dual Fuel Ranges

FREE-STANDING Models RDF30, RDFS30

SLIDE-IN Model RDSS30

DROP-IN Model RDDS30V

Thermador[®]

© 2002 BSH Home Appliances Corp.

TABLE OF CONTENTS



Safety Instructions2-7



Care and Cleaning

Self-Cleaning the Oven38,39
 Range Cleaning40
 Range Finishes/Cleaning Method41
 Cook'n'Vent® Care and Cleaning...43,44



Operating Instructions

Features of Your Range8,9
 What You Will Hear & See.....10

Cooktop

Cooktop Comparison.....11
 Proper Cookware12
 Cooktop Operation13,14
 ExtraLow®15
 Flame Setting Chart16

Oven

Oven Control Features17
 Setting the Clock/Timer18
 Child Lockout19
 Setting the Oven - Bake/Convection ..20
 Setting the Oven - Broiling20
 Setting the Oven - Auto Cook21
 Setting the Oven - Delay Auto22
 Setting the Oven-To Change Auto Cook..23



Cook'n'Vent®

Cook'n'Vent® Operation.....42
 Cook'n'Vent® Care and Cleaning...43,44



Problem Solver

Do-It-Yourself Maintenance45,46
 Solving Baking Problems37
 Solving Operational Problems47
 How To Obtain Service47



Using the Oven

Oven Racks24
 Slow Cooking/Holding Foods24
 General Oven Tips25
 Bake Techniques.....26
 Convection Techniques.....27
 Broil Techniques28
 Baking/Roasting/Broiling Charts...29-36
 Solving Baking Problems.....37



Consumer Services

Warranty48

A Special Message to Our Customers,

Thank you for buying a Thermador® Range. We recommend that you take the time to read this entire booklet before using your new appliance.

We hope that the information in this manual will help you easily operate and care for your Range for years of satisfaction.

Please contact us if you have any questions or comments. Thermador's® address and phone number are listed on page 47.

Sincerely,

Test Kitchen Consumer Scientists

208 Volt Connections

When using this oven on 120/208 volts, preheating times will be longer. The oven is preheated when the temperature display reaches the selected temperature.

When using Broil it is recommended to preheat. Preheat the broil element with the door open to the Broil Stop for 4 to 5 minutes or until the top element is red. Do not preheat with the broil pan in the oven.

WARNING:

If the information in this manual is not followed exactly, a fire or explosion may result causing property damage, personal injury or death.

- Do not store or use gasoline or other flammable vapors and liquids in the vicinity of this or any other appliance.

WHAT TO DO IF YOU SMELL GAS:

- Do not try to light any appliance.
 - Do not touch any electrical switch.
 - Do not use any phone in your building.
 - Immediately call your gas supplier from a neighbor's phone.
 - Follow the gas supplier's instructions.
 - If you cannot reach your gas supplier, call the fire department.
- Installation and service must be performed by a qualified installer, service agency or the gas supplier.



AVERTISSEMENT:

L'installation inexacte, l'ajustement, la modification, le service ou l'entretien peut causer la blessure ou la propriété endommagée. Se référer à ce manuel. Pour l'assistance ou l'information additionnelle consulter un installateur qualifié, une agence de service, le fabricant (le marchand) ou le fournisseur de gaz.

- Ne pas emmagasiner ou utiliser de l'essence ou d'autres vapeurs inflammables et liquides aux endroits de celui-ci ou aucun autre appareil.

CE QUI FAIRE SI VOUS SENTEZ LE GAZ:

- Ne pas essayer d'allumer aucun appareil.
 - Ne pas toucher aucun interrupteur électrique.
 - Ne pas utiliser aucun téléphone dans votre bâtiment.
 - Appeler immédiatement votre fournisseur de gaz du téléphone d'un voisin.
 - Suivre l'instruction du fournisseur de gaz.
 - Si vous ne pouvez pas contacter votre fournisseur, téléphoner le service des incendies.
- L'installation et le service doivent être exécutés par un installateur qualifié, une agence de service ou le fournisseur de gaz.



IMPORTANT SAFETY INSTRUCTIONS

Read all instructions before using this appliance.

IMPORTANT SAFETY NOTICE

- The California Safe Drinking Water and Toxic Enforcement Act requires businesses to warn customers of potential exposure to substances which are known by the State of California to cause cancer or reproductive harm.
- The burning of gas cooking fuel and the elimination of soil during self-cleaning generates some by-products which are on the list.
- The fiberglass insulation in self-clean ovens gives off a very small amount of formaldehyde during the first several cleaning cycles.
- To minimize exposure to these substances always operate this unit according to the instructions contained in this booklet and provide good ventilation to the room during and immediately after self-cleaning the oven.

SAFETY FOR ALL APPLIANCES

- Use this unit only in the manner intended by the manufacturer. If you have any questions contact the manufacturer.
- Be sure the range is properly installed and grounded by a qualified technician.
- Never use the oven or cooktop to warm or heat a room. Also such use can damage the cooktop or oven parts.
- Children should not be left alone or unattended in the area where the appliance is in use. They should never be allowed to sit or stand on any part of the appliance.
- Do not store flammable materials on or near the cooktop or in the oven.

- Do not use water on a grease fire. Smother fire or flame or use a dry chemical or foam-type extinguisher.
- Use only dry potholders. Moist or damp potholders on hot surfaces may result in burns from steam. Do not let potholder touch hot heating elements. Do not use a towel or other bulky cloth.
- Do not repair or replace any part of the appliance unless specifically recommended in this manual. All other servicing should be referred to an authorized servicer.
- In the event that personal clothing catches fire, DROP AND ROLL IMMEDIATELY to extinguish flames.
- As a precaution, it is highly recommended that a fire extinguisher be readily available and highly visible next to any cooking appliance.

	 WARNING
	<p>TO REDUCE THE RISK OF TIPPING OF THE APPLIANCE, IT MUST BE SECURED BY A PROPERLY INSTALLED ANTI-TIP DEVICE. TO CHECK IF THE DEVICE IS INSTALLED PROPERLY, REMOVE THE STORAGE DRAWER/KICK PANEL BELOW THE OVEN DOOR AND VERIFY THAT THE ANTI-TIP DEVICE IS ENGAGED PER INSTALLATION INSTRUCTIONS.</p>

IMPORTANT SAFETY INSTRUCTIONS

Read all instructions before using this appliance.



SAFETY FOR THE COOKTOP

- Do not touch the cooktop or the area immediately surrounding it.
 - Never leave the cooktop unattended at high heat settings. Boil over causes smoking and greasy spillovers that may catch fire.
 - Do not use aluminum foil to line any part of the cooktop or oven. Improper use of these liners could result in an electric shock or fire, or the obstruction of the flow of combustion and ventilation air. Foil is an excellent heat insulator and heat will be trapped beneath it. This will upset the cooking performance and can damage the finish.
 - Only certain types of glass, glass/ceramic, ceramic, earthenware or other glazed utensils are suitable for cooktop service without breaking due to the sudden change in temperature.
 - To reduce the risk of burns, ignition of flammable materials and spillage due to the unintentional contact with the utensil, the handle of a utensil should be positioned inward. Make sure the handle does not extend over adjacent work areas, cooking areas or the edge of the cooktop.
 - Have the installer show you where the gas shut-off valve is located so that you know how and where to turn off the gas to the cooktop.
 - Do not obstruct the flow of combustion and ventilation air.
 - If you smell gas, your installer has not done a proper job of checking for leaks. Connections can loosen in transit. If the connections are not perfectly tight, you can have a small leak and therefore a faint gas smell. Finding a gas leak is not a do-it-yourself procedure. Some leaks can only be found with the burner control in the ON position and this must be done by a qualified technician. Please see Page 1.
- The cooktop on your range is factory assembled for natural gas. It may be converted to propane gas. Your cooktop should be correctly adjusted by a qualified service person or installer for the type of gas with which it is used.
 - During cooking, for safety considerations, set the burner control so that the flame heats only the bottom of the pan and does not extend beyond the bottom of the pan. **The use of flat cookware will provide better stability on the burner grate and ensure the best performance.**
 - Take care that drafts like those from fans or forced air vents do not blow flammable material toward the flames or push the flames so that they extend beyond the edges of the utensil.
 - In the event a burner goes out and gas escapes, turn off the knob(s) and open a window or a door. Do not attempt to use the cooktop until the gas has had time to dissipate. Wait at least 5 minutes before using the range.
 - Never let clothing, pot holders or other flammable materials come in contact with or be too close to the burners while in operation. Fabric may ignite and result in personal injury. For personal safety wear proper apparel; loose fitting or hanging garments should never be worn while cooking.
 - In the event of a power failure, the standard gas burners or the ExtraLow[®] burners will not automatically light or relight.



IMPORTANT SAFETY INSTRUCTIONS

Read all instructions before using this appliance.

SAFETY FOR THE SELF-CLEANING OVEN

- Do not clean the door gasket. It is essential for a good seal. Care should be taken not to rub, damage, move or remove the door gasket.
- Do not use commercial oven cleaners or oven liner protective coatings of any kind in or around any part of the oven.
- Clean only the parts of the oven listed in this manual.
- Before self-cleaning the oven, remove the broiler pan, oven racks, other utensils and excess spillage.
- Do not leave food or cooking utensils etc., in oven during the self-cleaning mode of operation.

SAFETY FOR THE VENTILATING HOOD

- Clean the hood above the range or the intake at the back of the range frequently. Grease should not be allowed to accumulate on the hood/intake or the filters.
- When flaming foods, turn the hood/ intake fan ON.

WARNING: Do not store items of interest to children in cabinets above the range or at the back of it. Children climbing on the range to reach items could be seriously injured.

SAFETY FOR THE OVEN.

- Do not touch heating elements or interior surfaces of oven.
- The heating (bake and broil) elements may be hot though they are dark in color. Interior surfaces of an oven become hot enough to cause burns.
- During and after use, do not touch or let clothing or other flammable materials contact the heating (bake and broil) elements or the interior surfaces of the oven until they have had sufficient time to cool.
- The trim on the top and sides of the oven door of the range may become hot enough to cause burns.
- Use care when opening the door. Let hot air or steam escape before removing or replacing food.
- Do not heat unopened food containers. Buildup of pressure may cause the container to burst and result in injury.
- Do not block the oven vent ducts (located along the top of the backsplash, back trim, or cooktop).
- Always place oven racks in desired location while oven is cool. If a rack must be moved while oven is hot, do not let potholder contact the hot heating elements
- If F-1 or F-3 flashes in the display, follow instructions in "Solving Operational Problems."

LES INSTRUCTIONS DE SÉCURITÉ IMPORTANTE

Veillez lire les instructions entières avant de continuer



LA SÉCURITÉ POUR TOUS LES APPAREILS

- Utiliser cet appareil se ulement: dans la manière destinée par le fabricant. Si vous avez des questions, contacter le fabricant.
- Faire installer et mettre à la terre la cuisinière par un technicien qualifié.
- Ne jamais utiliser le Cooktop ou le four pour chauffer une chambre. Tel emploi peut endommager le Cooktop y la four.
- Les enfants ne doivent pas être laissés seuls ou sans surveillance dans un endroit ou les appareils sont en marche. Il ne dolt jamais être permis à laisser s'asseoir ou poser le pied sur aueune partie de l'appareil.

- Ne jamais utiliser aucune partie du cooktop ou dans du four pour l'emmagasinage.
- Ne pas utiliser de l'eau sur les feus de la graisse. Mettre l'appareil a l'arrêt et s'éteuffer le feu avec le bicarbonate de soude ou utiliser un extincteur de chimique sec ou de type écumé.
- Utiliser seulement les poignées sèches. Les poignées mouillées ou humides sur les surfaces chaudes peuvent causer les becs du vapeur. Ne pas utiliser une serviette ou d'autre tissu volumineux au lieu des poignées. Ne pas permettre les poignées de toucher les éléments chauds, les becs chauds, ou les grilles du bec.
- Ne pas réparer ou remplaceer aueune partie de l'appareil à moins que recommandé spécifiquement dans cernauel. Tout autre entretien dolt etre rapporté à un technicien qualifié.



AVERTISSEMENT:



POUR RÉDUIRE LE RISQUE D'INCLINAISON DE L'APPAREIL, IL DOIT ÊTRE FIXÉ PAR UN APPAREIL ANTI-RENVERSÉ, CORRECTEMENT INSTALLE. POUR YERIFIER SI L'APPAREIL EST INSTALLÉ CORRECTEMENT, ENLEVER LE TIROIR DES PROVISIONS EN DESSOUS DE LA PORTE DU FOUR ET VÉRIFIER QUE L'APPAREIL ANTI-RENVERSÉ EST ENGAGÉ PAR LES INSTRUCTIONS D'INSTALLATION.



LA SÉCURITÉ POUR LA CUISINIÈRE

NE PAS TOUCHER LES GRILLES DU BEC OU L'ENDRIOT ENTOURANT IMMÉDIATE.

- Ne jamais laisser le Cooktop sans surveillance en utilisant les réglages des hautes flammes. Les sur-bouillants peuvent causer le fumage et les debordes graisseux qui peuvent s'allumer.
- Ne pas utiliser le papier alu de border aucune partie de la cuisiniere ou le four. L'emploi impropre de ces revêtements peut résulter a un choc electrique ou un feu, ou l'obstruction le debit d'air de combustion et de ventilation. La feuille est un isolant de la chaleur excellent et la chaleur sera attrapée en bas d'elle. Ce bouleversera la performsance de la cuisine et peut endommager le fini.



LES INSTRUCTIONS DE SÉCURITÉ IMPORTANTE

Veillez lire les instructions entières avant de continuer

LA SECURITE POUR LA CUISINIERE

- Seulement certains types de verre, verre-céramique, résistant a la chaleur, céramique, la faïence, ou des autres ustensiles vitrés sont convenables pour l'utilisation du Cooktop. Ce type d'ustensile peut casser avec les changements de la température soudains.
- Pour minimiser les brûleurs d'ignition des matières inflammables et les débordés involontaires, mettre les poignées d'ustensiles vers l'intérieur pour qu'ils n'étendent pas sur les endroits de travaille adjacents, les endroits de cuisson, ou le bord du Cooktop.
- Ayez l'installateur de vous montrer où se trouve la soupape d'arrêt d'alimentation de gaz pour que vous savez comment et où de fermer le gaz au Cooktop.
- Si vous sentez le gaz, votre installateur n'a pas fait un travail correct pour contrôler les fuites. Si les branchements ne sont pas parfaitement serrés, vous pouvez avoir une petite fuite et par conséquent une odeur de gaz faible.
- En utilisant le Cooktop: **NE PAS TOUCHER LES GRILLES DU BEC OU L'ENDROIT ENTOURANT IMMÉDIATE.** Les endroits adjacents aux becs peuvent devenir assez chaudes de causer les brûleurs.
- De découvrir une fuite de gaz n'est pas une procédure du fait-it-toi-même. Quelques fuites peuvent seulement être repérées avec la commande de bec à la position EN MARCHE et ce doit être fait par un technicien de service qualifié. Voir Page 1.
- Votre Cooktop est assemblé à l'usine pour le gaz naturel. Votre cooktop doit être converti correctement par une personne de service qualifiée ou l'installateur pour le type de gaz avec lequel il est utilisé.
- Pendant la cuisson, mettre la commande de bec pour que la flamme chauffe seulement le fond de la casserole et ne pas étendre au-delà du fond de la casserole.
- L'emploi de la cuisine plate fournira la meilleure stabilité sur la grille du bec et assurera la meilleure performance.
- Prendre soin que les courants d'air comme ceux des ventilateurs ou les événements forcés ne soufflent pas la matière inflammable vers les flammes ou poussent les flammes pour qu'ils s'étendent au-delà des bords de l'ustensile.
- Dans le cas qu'un bec s'éteint et le gaz s'échappe, ouvrir une fenêtre ou une porte. Ne pas tenter d'utiliser le Cooktop jusqu'à ce que le gaz a eu le temps de dissiper. Attendre au moins de 5 minutes avant d'utiliser le Cooktop.
- Ne jamais laisser les habillements, les poignées, ou des autres matières inflammables de contacter ou d'être trop près d'aucun élément, bec ou grille du bec, jusqu'à ce qu'il a refroidi. Le tissu peut s'allumer et résulter à la blessure personnelle.
- Dans l'événement d'un manque de courant, les becs de gaz normaux ou les becs ExtraLow® n'allumeront pas ou réallumeront automatiquement.

LES INSTRUCTIONS DE SÉCURITÉ IMPORTANTE

Veillez lire les instructions entières avant de continuer



LA SÉCURITÉ POUR LE FOUR AUTONETTOYANT

- Ne pas nettoyer le joint de la porte. C'est essentiel pour un bon sceau. Le soin doit être pris de ne pas frotter, endommager, remuer ou enlever le joint de la porte.
- Ne pas utiliser les nettoyeurs du four commerciaux ou les revêtements de protection du revêtement du four d'aucunes sortes dans ou autour aucune partie du four.
- Nettoyer seulement les parties du four inscrites dans ce manuel.
- Avant de auto-nettoyer le four. enlever la casserole du gril, les étagères du four, les autres ustensiles et un excédent de liquide.
- Ne laisser aucun aliment, ustensile de cuisine, etc., dans le four durant le cycle d'autonettoyage.

LA SÉCURITÉ POUR LE CAPOT D'AERATION

- Nettoyer les événements de la cuisinière fréquemment. La graisse ne devrait pas être laissée d'accumuler sur le capot ou l'aérateur à l'arrière de la cuisinière ou sur leurs filtres.
- Laisser le capot/le ventilateur en marche en flambant la nourriture.

AVERTISSEMENT: Ne pas emmagasiner des articles d'intérêt aux enfants au-dessus du Cooktop ou au dos de lui. Si les enfants grimperaient sur l'appareil d'atteindre ces articles, ils peuvent être sérieusement blessés.

LA SÉCURITÉ POUR LE FOUR

NE PAS TOUCHER LES ÉLÉMENTS DE CHAUFFAGE OU LES SURFACES INTÉRIEURES DU FOUR

- Les éléments de chauffage (cuire au four et griller) peuvent être chauds bien qu'ils sont foncés en couleur. Les surfaces intérieures d'un four s'échauffent assez de causer les brûlures.
- Pendant et après l'utilisation, ne pas toucher ou permettre l'habillement ou d'autres matières inflammables de contacter les éléments de chauffage (cuire au four et griller) ou les surface intérieures du four jusqu'à ce qu'elles ont eu le temps suffisant de rafraîchir.
- * Les moulures sur le sommet et les côtés de la porte du four de la cuisinière peuvent s'échauffer assez de causer les brûlures.
- Utiliser le soin en ouvrant la porte. Permettre l'air chaud ou la vapeur d'échapper avant d'enlever ou de remplacer la nourriture.
- Ne pas chauffer les récipients de la nourriture non ouvert: une intensification de pression peut causer le récipient d'éclater.
- Ne pas obstruer les conduits de ventouses du four (situés au sommet du dos d'éclaboussure).
- Toujours mettre les étagères du four à l'endroit désiré pendant que le four soit frais. Si une étagère doit être déplacée quand le four est chaud, ne pas permettre la poignée de contacter les éléments de chauffage chauds.



FEATURES OF YOUR RANGE

Not all features are on all models

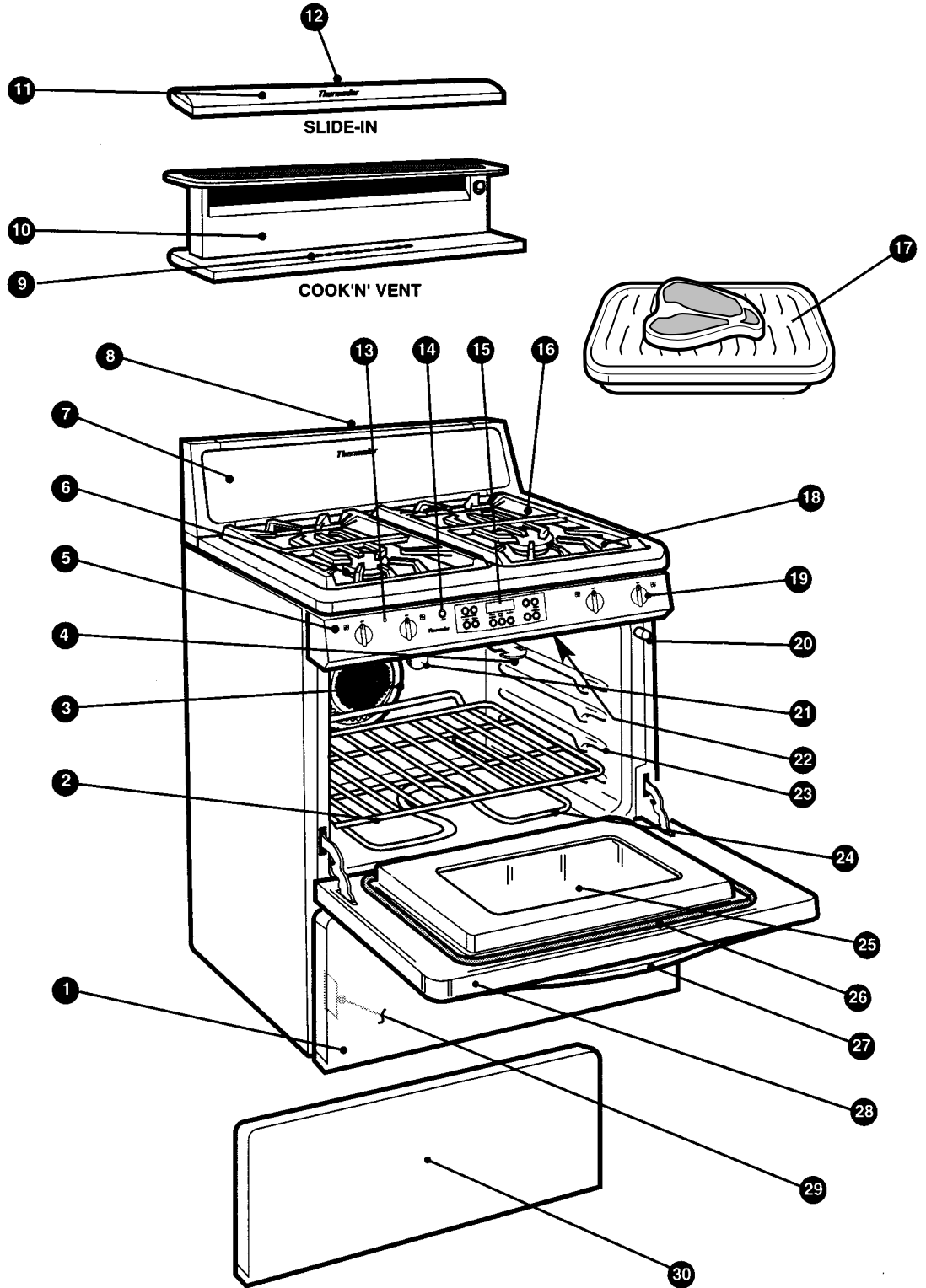

FEATURES OF YOUR RANGE

Not all features are on all models



Feature Index	Explained on page	Feature Index	Explained on page
1 Storage Drawer Push to Open Models RDF/RDFS/RDSS	40	15 Oven Control Clock and Timer	17-23
2 Oven Racks	24, 38, 40	16 Burner Grates	13, 40
3 Convection Fan	10, 27	17 Broil Pan and Grid	28, 40
4 Motorized Door Latch	10, 39	18 Recessed Spillage Well	40
5 Burner Identification	13	19 Cooktop Control Knobs	13, 15, 40
6 Sealed Gas Burners	11, 13, 40	20 Automatic Oven Light Switch	17, 45
7 Backsplash Models RDF/RDFS	40	21 Oven Light	17,38,45,47
8 Oven Vent Do Not Block Models RDF/RDFS	8	22 Broil Element	28
9 Oven Vent Do Not Block Model RDSS	8	23 Rack Guides	24
10 Cook'n'Vent® Model RDSS	42, 43, 44	24 Bake Element	26
11 Slide-In Back Trim Model RDSS	40	25 Viewing Window Thoroughly Wipe Before Self-Cleaning	38, 40
12 Oven Vent Do Not Block Models RDSS	8	26 Oven Door Gasket	38, 40
13 Burner "ON" Light RDFS/ RDSS/ RDSS only	10, 14	27 Oven Door Handle	40
14 Oven Light Switch	17	28 Removable Oven Door	40, 46
		29 Data/Serial Tag Remove Storage Drawer or Glass/Wood Panel to Access	48
		30 Drop-In Accessory Glass Panel or Custom Wood Panel	40



WHAT YOU WILL HEAR & SEE

WHAT YOU WILL HEAR

Convection Fan

Operates during any convection program. It also turns on automatically during the clean cycle.

Spark Ignition

A clicking sound following the push-and-turn of any gas burner control knob. This sound is the igniter sparking to light the burner. Knobs set in the XLO® Zone (---XLO) will spark every minute to ignite the flame. (RDFS/RDSS/RDDS models)

"Popping" When Burner Turned Off

An audible "pop" may be heard when the burner is turned off manually, or when cycling in the XLO® zone (RDFS/RDSS/RDDS models). The "popping" may be louder with LP gas than with natural gas.

Oven Audible Signals

1. Three 1 second beeps followed by one beep every 10 seconds for any of the following conditions:
 - Timer has counted down to zero.
 - End of any timed cooking cycle.
 - Door is not locked in a self-clean cycle.
2. One second beep every 4 seconds (1 second on, 3 seconds off)
 - Indicates a failure. This sequence will continue until the failure is acknowledged as described in 'Solving Operational Problems', page 47.
3. One short beep
 - The sound you hear every time a pushbutton is pressed on the control panel (except the + / - pushbuttons).
 - Also an "attention" beep to signal that another input is needed to complete programming. If the programming is not completed in 16 seconds, the program will automatically cancel.

Cook'n'Vent® Blower (RDDS30V model)

Turns on automatically when the intake is raised and the control knob is set to 1, 2, or 3.

WHAT YOU WILL SEE

Burners Cycling On and Off While Cooking (RDSF/RDSS/RDDS models).

The flame on the XLO® burners will cycle on and off every minute according to the setting selected in the XLO® zone.

Cooktop Burner "ON" Light

The light will turn on any time a burner is in use.

Control Panel Flashing (1 second on and 1 second off)

1. Any flashing in the control window indicates that the selected function is not completely programmed.
2. Indicates a power-up flashing. The time of day (may need adjustment) flashes following the initial application of power to the unit or after a power failure.

"Locked" Light in Display

When the "Locked" light is displayed, **the oven door will not open**. Wait for the light to disappear, designating that the motorized door latch is in the open position before opening the door.

Cook'n'Vent® Intake (RDDS30V model)



Raises to operating position when UP/DOWN pushbutton is pressed once. It is not necessary to hold pushbutton. Lowers to hidden position when UP/DOWN pushbutton is pressed again.

COMPARISON OF COOKTOP SYSTEMS

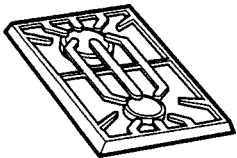

Your new cooktop has sealed gas burners. If you are familiar with cooking on another type of cooktop, you will notice some differences.

The chart below will help you to understand and compare the differences between your new cooktop and other types of cooktops.

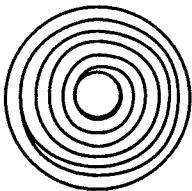
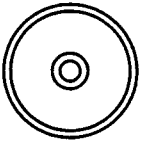
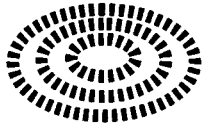
Type of Cooktop	Description	How it Works
Gas Burners 	Sealed gas burners operate on natural or propane gas.	Gas flames heat the pan directly. Use well balanced pans for stability, but flatness is not critical for cooking performance. Gas burners provide instant control of heat.
Radiant Element (Glass Ceramic) 	Electric coils under a glass ceramic cooktop.	Heat from the element travels through the glass. Flat bottom pans are critical for best cooking results. The glass will remain hot after the element has been turned off. Remove pan from glass to stop cooking, or use the retained heat to finish cooking.
Electric Coil 	Flattened metal tubing over a drip pan.	Heats by direct contact with the pan. Use flat bottom pans for best cooking results. Limited use of warped pans is acceptable. Heats up quickly but does not give you instant control like gas or induction. Electric coils will briefly remain hot after they are turned off.
Solid Disk 	Solid cast iron disk sealed to the cooktop surface.	Heats by direct contact with the pan. It is critical that pans be flat on the bottom for good results. Slowly heats up and slowly cools down. The disk will remain hot after it is turned off. Remove the pan from the disk to stop cooking, or use the retained heat to finish cooking.
Induction 	Electro-magnetic coils under a glass ceramic surface.	Heat is produced by a magnetic circuit between the coil and the pan. Pan must be made of ferrous or magnetic material (metal that attracts a magnet). Induction gives you instant control of heat. The glass cooktop will remain hot from the heat of the pan when turned off, but cooking stops right away.



PROPER COOKWARE

Cookware characteristics

- Pans with aluminum or copper imbedded on a stainless steel disk conduct heat evenly.
- Steel pans, if not combined with other metals may cook unevenly.
- Cast-iron cookware absorbs heat slowly, but cooks evenly at low to medium settings.
- **Flat, heavy bottom pans provide even heat and stability.** Thin pans are not recommended.
- Warped, dented or ridged cookware heats unevenly. Avoid use of such pans.

Cookware should have the following characteristics:

Match Pan Diameter to Flame Size

Do not let flames lick up the sides of the pan. The flame should be the same size as the pan or smaller.



Use Flat Bottom Wok

Use only a flat bottom wok. A round bottom wok with its support ring is not recommended.



Use Balanced Pans

Pans must sit level on the cooktop grate without rocking.



Use a Good Fitting Lid

Use lids that fit the cookware properly to help shorten the cooking time.

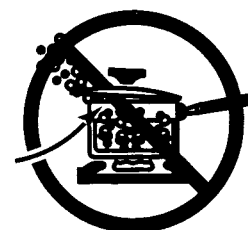
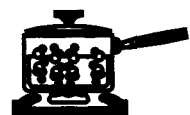

CANNING:

- Canner and stockpot diameters should not extend beyond the burner grate.
- Use lowest heat setting possible to maintain a boil or pressure (for pressure canners).
- Use care to prevent burns from the large amounts of steam generated by the canning process.

Pressure cookers must meet the same requirements as described above.

COOKTOP OPERATION

The following pages explain how each feature on the gas cooktop works and how to get the best cooking results.

Follow these hints when cooking on the cooktop:

- Use proper cookware, see page 12.
- Center the pan on the burner grate before turning the burner on.
- Use cookware that is large enough to accommodate the quantity of food or liquid being cooked to eliminate boil overs and spattering.
- To cook a particular food, see page 16 for suggested flame settings.

Burner Control Knobs

The standard burner controls have an infinite number of heat settings with no fixed positions. Select the appropriate control knob, push in and turn it counterclockwise to the desired flame size; HI through LO, or optional XLO™ on left two burners. (See page 15 for information on XLO® burners.) Turn off by turning the control knob clockwise to OFF.

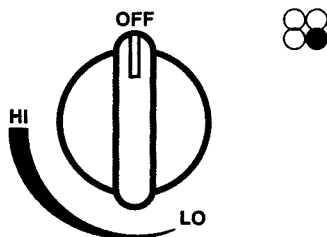

STANDARD BURNER CONTROL

Burner Identification

On the outside of each pair of control knobs is the symbol identifying the location of the burner that the knob controls. For example, the solid circle in this diagram means the knob controls the left front burner.

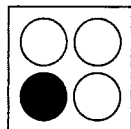

WARNING: For proper combustion do not use the cooktop without the burner caps or the burner grates in place.

ATTENTION: Pour la combustion adéquate ne pas utiliser le cooktop sans les grills de bec en place.

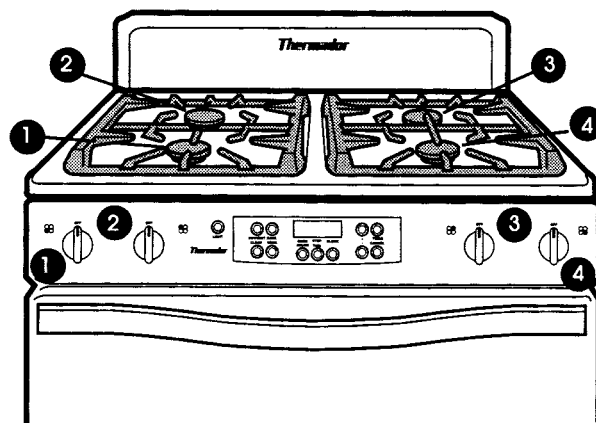

- 1 Left front control knob and burner (XLO® - Model RDFS/RDSS/RDDS)
- 2 Left rear control knob and burner (XLO® - Model RDFS/RDSS/RDDS)
- 3 Right rear control knob and burner (standard)
- 4 Right front control knob and burner (standard)

Sealed Burners

Your new cooktop features four sealed gas burners. Since each burner is sealed to the cooktop, there are no burner parts under the cooktop to clean or reassemble.

Burner Caps

The burner cap is an aluminum alloy head topped by a porcelain enameled steel cap. On the underside of the cap is one **locator** which **must** fit into the corresponding notch on the burner base. **If the burner cap does not fit correctly, the burner may not light or the flame will not burn completely or correctly.**

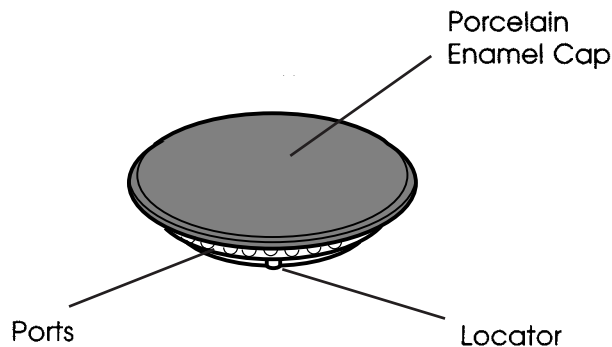

BURNER CAP



COOKTOP OPERATION

Electronic Ignition/Reignition

The cooktop uses electronic igniters to light the burners. **There is no pilot light.** Each burner has its own igniter.

When turning on any burner or if any burner flame blows out, the electronic igniter automatically sparks on all burners to relight the flame.

The burner should light in 4 seconds or less. If a burner does not light, check to see that the cap is positioned correctly on the burner base.

CAUTION: All four igniters spark when **any** burner is being turned on. Do not touch the burners when the igniters are clicking (sparkling) or if the XLO[®] feature (RDFS/RDSS/RDDS) is in use.

ATTENTION: Tous les quatres igniteurs ont des étincelles quand on commence à faire marcher aucun bec. Ne pas toucher les becs quand les igniteurs cliquent (avoir d' étincelles) ou si la fonction XLO[®] (RDFS/RDSS/RDDS) est en marche.

The ignitor should be clean and dry for proper sparking.

- Avoid getting excess water, food or soil on the igniter.
- If the igniter becomes too wet or soiled, it may continue to click without igniting the burner.
- If the burner does not ignite in 4 seconds, turn off the control knob and wait until the igniter is dry.

If a burner fails to ignite, see Solving Operational Problems, page 47.

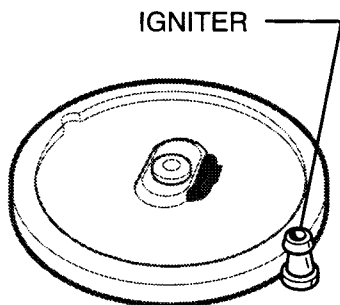

BURNER BASE

Burner "ON" Lights RDFS/RDSS/RDDS only

The "ON" light for all the burners is located between the left two burner knobs. When lit, it indicates that a burner is in use.

Burner Efficiency and Flame Characteristics

The burner flame should be blue in color and stable with no yellow tips, excessive noise or fluttering. It should burn completely around the burner cap.

Foreign particles in the gas line may cause an orange flame during initial use. This should disappear with use.

If the flame does not burn evenly all the way around the burner cap, be sure the cap is resting correctly on the burner base. Check the burner cap to make sure port holes are not obstructed. If the ports are clogged, use a straightened paper clip, a wire, or a needle to clear the port. **Do not use a toothpick.**

CAUTION:

Do not use aluminum foil directly on the burner grate for cooking. Aluminum foil can melt. Do not use or allow plastic, paper, or cloth to come in contact with a hot burner or grate. Do not allow pans to boil dry. This can damage the pan, the burner grate, or the cooktop.

ATTENTION:

Les nourritures emballées dans le papier alu ne doivent pas être mis directement sur la grille du bec pour la cuisson: le papier alu peut fondre. Le plastique, le papier et le tissu peuvent fondre ou brûler quand en contact avec une grille du bec chaude. Ne pas laisser ces articles de mettre en contact avec la grille du bec. Ne pas laisser les casseroles de bouillir sèches. Celui-ci peut endommager la casserole, la grille du bec, le cadre le plus haut métal, et/ou le capot du bec et la base.

Power Failure

In the event of a power failure, only the standard burners can be lighted manually. The XLO[®] burners on the left on model RDFS/RDSS/RDDS cannot be lit manually.

In a power failure, it is necessary to light each standard series burner individually.

If the cooktop is being used when the power failure occurs, turn all the burner control knobs to the **OFF** position. Then, the standard burners can be lighted by holding a match at the ports and turning the control knob to the **HI** position. Wait until the flame is burning all the way around the burner cap before adjusting the flame to the desired height.



WARNING:

The Reignition feature will not work in the event of a power failure.



AVERTISSEMENT:

La fonction de Ré-allumage ne fera pas fonctionner dans l'événement d'un manque de courant.

COOKTOP OPERATION - ExtraLow[®] BURNERS

(Models RDFS/RDSS/RDDS)



This feature not on all models

Thermador[®] ExtraLow[®] Burners

The **two left** burners are designed to provide a wide range of flame settings. The left front burner ranges from 300 to 9,100 BTU/HR. The left rear burner ranges from 365 to 11,000 BTU/HR. This flexibility in heat settings allows you to quickly bring large quantities of liquid to a boil or simmer, poach, melt or hold cooked food without scorching or burning. This is achieved by automatically cycling the flame OFF and ON for varying lengths of time within the XLO[®] zone.

Note: The ExtraLow[®] Burners have a higher BTU rating on "LO" than the Standard Burners.

How They Work

- The burner flame will cycle ON and OFF each minute when the setting is at any position between **LO** (past detent) and **XLO[®]**.
- There are an infinite number of settings between **LO** (past detent) and **XLO[®]**; the control knob can be set at any position.
- The length of time the flame is ON and OFF depends on the knob setting.
- With a setting just below **LO**, the flame will be **ON** approximately 53 seconds and **OFF** 7 seconds **of each minute**.
- With a setting at the **XLO[®]** position, the flame is **ON** approximately 7 seconds and **OFF** 53 seconds **of each minute**.

For Best Results

- Temperature control will be more accurate if a lid is used.
- Bring food to a rolling boil; stir well to be sure all the food is boiling; cover and reduce the heat in the XLO[®] zone.
- Check periodically to see if the control knob should be turned to a lower setting.
- It is normal to stir food occasionally.
- If the control knob is set too low to maintain simmer, bring the food back to a boil before setting a higher simmer setting.
- While the flame is ON there may be bubbling; there should be at least steam and a slight quivering of the liquid's surface.
- Simmer bubbles may not be seen when the flame has cycled OFF.

For a complimentary cookbook on how to fully use the XLO[®] burner, send in the product registration card included in the literature package.

The number designations in the XLO[®] zone are for reference only and are guides to the flame settings referenced in the Suggested Flame Setting Chart, page 16.

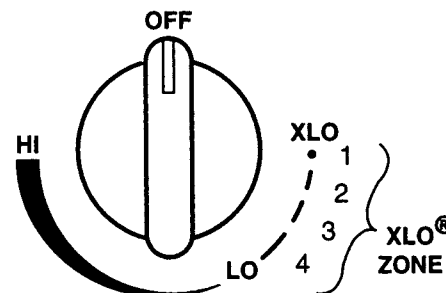

EXTRALOW[®] BURNER CONTROL



CAUTION: Do not clean or touch any of the burners when one or both XLO[®] burners are in use.



ATTENTION:

Ne pas nettoyer ou toucher aucuns des becs quand le bec XLO[®] est en marche.

IMPORTANT: The two XLO[®] burners cannot be used during a power failure. Be sure to turn knobs OFF if a power failure occurs. The burners will not turn back on until both control knobs are turned OFF and then turned back ON again after power has been restored. See "What To Do If You Smell Gas" on page 1.

Note: ExtraLow[®] is referred to in this manual as XLO[®].



SUGGESTED FLAME SETTING CHART

Food	Start Cooking	Continue Cooking Standard Burners	OR Continue Cooking ExtraLow® Burners
BREADS French Toast, Pancakes, Grilled Sandwiches	Med. - preheat skillet	Med. Lo to Med. cook	Use standard burner setting
CEREALS Cornmeal, Grits, Oatmeal	HI - cover, bring water to a boil, add cereal.	Med. Lo to Med. - finish cooking according to package directions.	2 to XLO® - to hold, cover*
CHOCOLATE	LO to melt*	Remove when melted.	2 to XLO® - allow 10 to 15 minutes to melt. 1 to XLO® - to hold*
DEEP FRYING	HI - heat oil	Med. HI to HI - to maintain temperature	Use standard burner setting
EGGS Cooked in Shell	HI - cover, bring water to a boil, add eggs, cover	OFF to Low - cook 3 to 4 minutes for soft cook- ed; or 15 to 20 minutes for hard cooked.	2 to XLO® - cook 3 to 4 minutes for soft cooked ; or 15 to 20 minutes for hard cooked
Fried, Scrambled	Med. to Med. HI - melt butter, add egg	LO to Med. Lo - finish cooking	2 to XLO® - to hold cover, for a short period*
MEAT, FISH, POULTRY Bacon, Sausage Patties	HI - until meat starts to sizzle	Med. Lo to Med. - to finish cooking	Use standard burner setting
Braising: Swiss Steak, Pot Roast	HI - melt fat, then brown on Med. HI to HI , add liquid, cover	LO to Med. Lo - cover, simmer until tender	3 to 2 - simmer until tender
Frying: Chicken	HI - melt fat, then brown on Med.	LO - cover, finish cooking	Use standard burner setting
Pan Frying: Lamb Chops, Thin Steaks, Hamburgers, Link Sausage	Med. HI to HI - preheat skillet	Med. to HI - brown meat	4 to 3 - hold, uncovered 3 to 2 - hold, covered
Simmering: Stewed Chicken, Corned Beef, Poaching Fish	HI - cover, bring liquid to a boil	LO to Med. Lo - simmer slowly.	4 to 1 - simmer slowly
RICE	HI - cover, bring water to boil, add rice, cover.	LO to Med. Lo - cover, cook according to package directions.	4 to 2 - cook according to package directions 2 to XLO® - hold, cover
POPCORN	Med. HI - cover, heat until kernels start to pop	Med. to Med. HI - finish popping	Use standard burner setting
PRESSURE COOKER Meat, Vegetables	Med. HI to HI - build up pressure	Med. Lo to Med. - maintain pressure	Use standard burner setting
SAUCES Tomato Base	Med. HI to HI - cook meat/vegetables, follow recipe	LO to Med. Lo - simmer	2 to 1 - simmer* (2 to 3 to thicken sauce, uncovered)
White, Cream, Bernaise, Hollandaise	LO - Med. Lo - melt fat, follow recipe	LO to Med. Lo - finish cooking	2 to XLO® - to hold, cover
SOUPS, STEWS	HI - cover, bring liquid to a boil	LO to Med. Lo - simmer	3 to 2 - simmer*, 2 to XLO® - to hold, simmer
STIR FRY	HI - heat oil, add vegetables	Med. HI to HI - finish cooking	Use standard burner setting
VEGETABLES Fresh	HI - cover, bring water and vegetable to a boil	Med. Lo to Med. - cook 10 to 30 minutes, or until tender	2 to XLO® - to hold, simmer

*Stir occasionally

OVEN CONTROL FEATURES



The control panel contains a series of pushbuttons that enable you to program the oven. As you press the pushbuttons, you will notice that numbers and words appear in the display window. These prompts tell you what is set and what must be done next. Take a moment to familiarize yourself with these controls. **To program the control, press only one button at a time.**

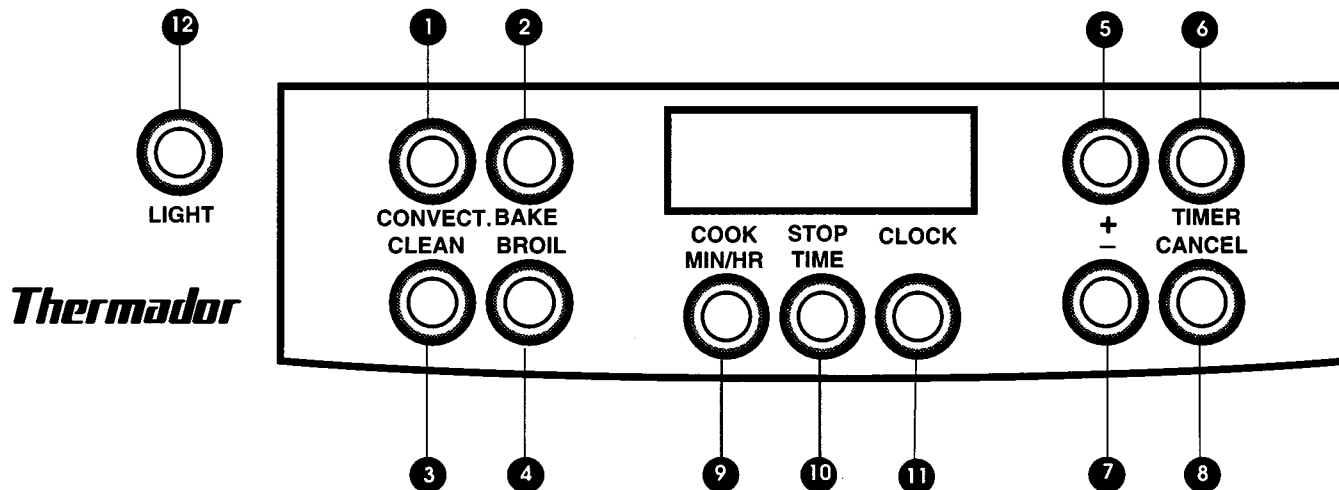

Thermador

- 1 Convect.** Press to select the convection mode.
- 2 Bake** Press to select the bake mode.
- 3 Clean** Press to select the self-clean function.
- 4 Broil** Press to select the broil mode.
- 5 + (Increase)** Press to increase time or temperature. Push once to increase by a single increment; or press and hold for 7 seconds to increase at a more rapid pace.
- 6 Timer** Press to set the (Minute) Timer. **Press to cancel the (Minute) Timer.**
- 7 - (Decrease)** Press to decrease time or temperature. Push once to decrease by a single increment; or press and hold for 7 seconds to decrease at a more rapid pace.
- 8 Cancel** Press to cancel any cooking/cleaning mode. **Pressing cancel does not cancel the Timer or the Clock.**
- 9 Cook (time) MIN/HR** Press to set cooking time in minutes or hours for either bake or convection mode. The oven will stop automatically after the cook time has ended.
- 10 Stop Time** Press after setting Cook (time) MIN/HR or Clean for the Time of Day the oven will stop automatically.
- 11 Clock** Press to set the Time of Day on the 12 hour clock.
- 12 Oven Light** Press to turn the oven light on /off to view inside of the oven with the door closed. When the oven door is opened, the oven light will automatically turn on. **The oven light will not turn on when the oven is set for a self-clean cycle.**

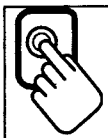

SETTING THE CLOCK/TIMER

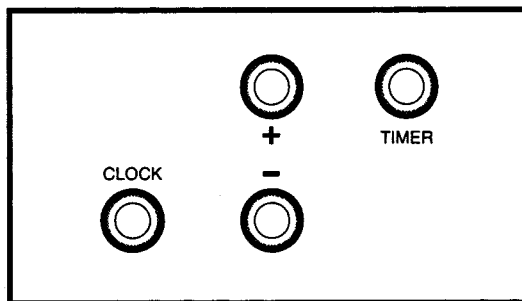

The display on the control will flash when power is first supplied to the range or if there has been a power failure. Once the Time of Day clock has been set, the display will stop blinking.

To Set the Clock

Your range has a 12 hour clock and does not indicate AM or PM. The Time of Day is displayed in hours and minutes.

1. Press the **CLOCK** pushbutton **once**.
 - The word **TIME** appears in the window while the Time of Day is set.
2. Press the **+** or **-** pushbuttons to set the correct Time of Day.
 - The word **TIME** disappears after 6 seconds.

- If you select **CLOCK** and do not press another pushbutton within 6 seconds, the operation will automatically cancel. Simply press the **CLOCK** pushbutton again.
- Do not hold the **CLOCK** pushbutton while pressing the **+** or **-** pushbutton.
- If you overshoot the desired time, simply press the **+** or **-** pushbutton for the opposite direction.
- The **CLOCK** time cannot be changed when the oven is set for a **BAKE**, **BROIL** or **CLEAN** operation. Cancel the operation to set the clock.
- Press the **CLOCK** pushbutton to recall the Time of Day when another function is displayed. The Time of Day will be displayed for 6 seconds and then will resume control operation.

To Set the Timer

1. Press the **TIMER** pushbutton once.
 - The word **TIMER** and **:00** appear in the window.
2. Press the **+** or **-** pushbuttons until the desired time appears.

- **The timer is a minute timer, it does not control any oven function.**
- The maximum setting on the timer is 9 hours, 55 minutes.
- To change the timer at an accelerated rate, press and hold either pushbutton. The time change will accelerate after the pushbutton is held for 7 seconds.
- When setting the timer for 1 or more hours, the window displays **HR**.

The time automatically starts to count down 3 seconds after the timer is set. The timer will signal with 3 beeps, followed by 1 beep every 10 seconds when the time has counted down.

To Cancel the Timer

1. Press the **TIMER** pushbutton once. The Time of Day will appear in the display window.
 - **DO NOT** press **CANCEL** if the oven is programmed to cook or clean, this will cancel the oven program, but not the timer.

Resetting the Timer While it is Counting Down

1. Press the **+** or **-** pushbutton until the new time appears.
 - The timer will resume counting down 3 seconds after the pushbutton is released.



CHILD LOCKOUT

The oven has a provision for locking the control panel in the **OFF** position. This mode prevents accidentally turning on the oven while cleaning the control panel or from a child playing with the pads. Oven modes which are locked are **BAKE**, **BROIL**, **CONVECTION**, or **SELF CLEAN**. The features which can always be used regardless of a lockout are: **TIMER**, **CLOCK** and oven **LIGHT**.

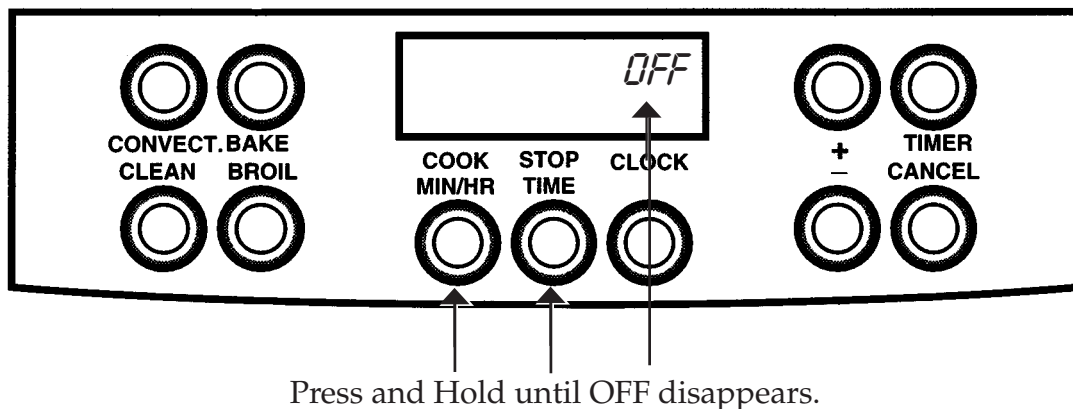

TO SET CHILD LOCKOUT

Press and hold the **COOK MIN/HR** and **STOP TIME** buttons until indicator word **OFF** appears in the display (approximately 6 seconds).

TO CANCEL THE CHILD LOCKOUT

Press and Hold the **COOK MIN/HR** and **STOP TIME** buttons until indicator word **OFF** disappears from the display (approximately 6 seconds). Mode selections will now be available on the control panel.



SETTING THE OVEN BAKE OR CONVECTION

To Set Bake or Convection

1. Press the BAKE or CONVECT. (Convection) pushbutton once.
2. Press the + or - pushbutton until the desired oven temperature (170° to 550°F) appears.
 - The word ON and the actual oven temperature, 100°F or above, appears in the window, and the oven begins to heat.
 - The oven is preheated when the selected temperature is displayed.
3. Optional: Set the TIMER for the minimum cooking time. See page 18.

NOTE: To see the set oven temperature while the oven is heating, press the BAKE or CONVECT. pushbutton once.

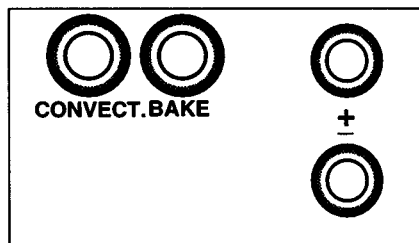

To Cancel Bake or Convection

1. Press the CANCEL pushbutton once to turn off the oven.
 - The BAKE or CONVECTION program cancels and the oven turns off. Only the Time of Day is displayed.

To Change the Oven Temperature

1. Press the BAKE or CONVECT. pushbutton once.
2. Press the + or - pushbutton until the new desired temperature appears.
 - The oven will now reach and maintain the new temperature.

BROIL

To Set Broil

1. Press the BROIL pushbutton once.
2. Press the + or - pushbutton for HI broil setting.
3. For a setting lower than HI, press the - pushbutton until the desired setting appears in the display (5,4,3,2,LO).
 - The word ON appears in the window after 6 seconds and the broiler begins to heat.
4. Optional: Set the (Minute) TIMER for the minimum broil time or as a reminder to turn over the food, see page 18.

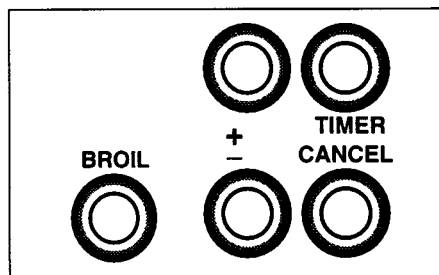

To Change the Broil Setting

1. Press the BROIL pushbutton once.
2. Press the + or - pushbutton until the new desired setting appears.
 - The setting range (HI,5,4,3,2,LO) can be changed at any time while broiling.

To Cancel Broil

1. Press the CANCEL pushbutton once.
 - Only the Time of Day remains displayed in the window if the TIMER is not in use.
 - The TIMER, if programmed, continues to count down until you press the TIMER pushbutton once.

For Broil Techniques, see page 28.

For correct Broil rack position,
see page 36.

SETTING THE OVEN



BAKE OR CONVECTION - AUTO COOK

Use this function to start cooking now, then stop the oven automatically while baking or roasting using either the Bake or Convection mode.

IMPORTANT: Be certain the CLOCK is set for the correct Time of Day before setting the oven for AUTO COOK.

FOR WARNINGS REGARDING FOODS TO BE COOKED USING AUTO COOK, SEE PAGE 22.

POUR AVERTISSEMENTS CONCERNANT LES NOURRITURES QUI SERONT CUITES EN UTILISANT L'AUTO-CUISINER VOIR page 22.

Note: Foods left in the oven, after the oven has turned off, may overcook.

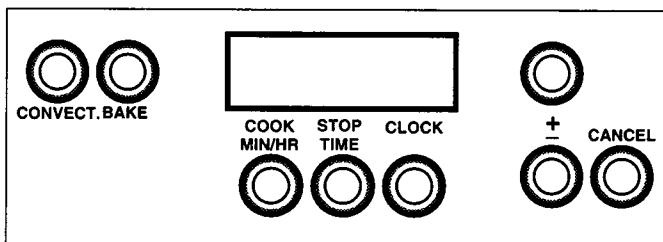

To Start Cooking Now (oven automatically turns off)

1. Press the BAKE or CONVECT. (Convection) pushbutton once.
2. Press the + or - pushbutton until the desired temperature appears.
 - The word ON and the actual oven temperature, 100°F or above appears in the window; after 6 seconds the oven begins to heat.
3. Press the COOK MIN/HR pushbutton once. See note 1 below.
4. Press the + pushbutton until the length of time **you** want the food to cook appears. See NOTES 2 and 3 below.
 - The cooking time appears in the window. See NOTES 4 and 5 below.

If any baking information is still required after the time information has been accepted, the necessary function word will begin to flash. If no function is selected, the mode will automatically cancel after 16 seconds.

To Cancel an Auto Cook Program

1. Press the CANCEL pushbutton once.
 - Only the Time of Day remains displayed in the window if the TIMER is not in use.

NOTES:

1. You must set an oven temperature before a Cook MIN/HR. time.
2. The COOK (time) MIN/HR can be set in 5 minute increments to cook for as long as 11 hours, 59 minutes.
3. The STOP TIME is automatically set when the COOK MIN/HR is set. To check the STOP TIME, press the STOP TIME pushbutton once. After 6 seconds, the bake time is again displayed.
4. At the end of the cooking program, the oven will turn off and three 1 second beeps will sound. A reminder signal will beep every 10 seconds for 5 minutes or until you press CANCEL.
5. To check the Time of Day during an Auto Cook program, press the CLOCK pushbutton once. After 6 seconds, the remaining COOK MIN/HR is again displayed.

To Change a BAKE or CONVECTION Auto Cook Program, see page 23.



SETTING THE OVEN

BAKE OR CONVECTION - DELAY AUTO COOK

Use this function to delay start and stop oven automatically while baking or roasting using either the Bake or Convection mode.

Note: Foods left in the oven, after the oven has turned off, may overcook.

IMPORTANT: Be certain the CLOCK is set for the correct Time of Day before setting the oven for AUTO COOK.

WARNINGS REGARDING FOODS TO BE COOKED USING AUTO COOK

Many foods (unless frozen when placed in the oven) can be held no longer than two hours before the start of cooking.

Foods that spoil easily must not be cooked using delay start. Some of these foods contain the following: milk, fish, stuffing, poultry and eggs. These kinds of foods are susceptible to bacteria growth which occurs rapidly at temperatures between 40° and 140°F.

AVERTISSEMENTS CONCERNANT LES NOURRITURES QUI SERONT CUITES EN UTILISANT L'AUTO-CUISINER.

Beaucoup de nourritures (sauf si gelés quand mis dans le four) ne peuvent pas être tenues de plus long que deux heures avant le début de la cuisine.

Les nourritures qui gâtent facilement ne doivent pas être cuites en utilisant le début du délai. Quelques de ces nourritures contiennent les suivants: le lait, le poisson, la farce, la volaille et les oeufs. Ces sortes de nourritures sont susceptibles à l'augmentation de la bactérie qui produit rapidement aux températures entre 4° et 60°C.

Les nourritures laissées dans le four, après que le four a été mis à l'arrêt, peuvent trop cuire.

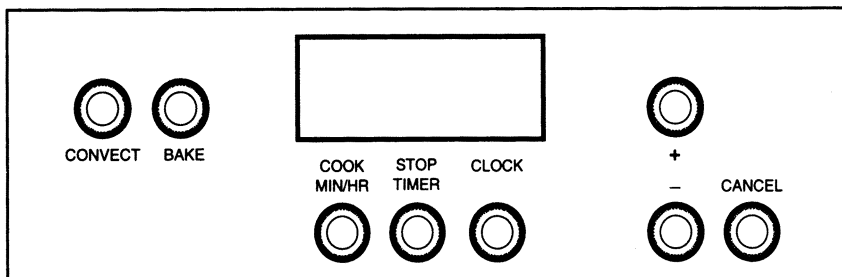

To Start Cooking Later (oven automatically turns on and off)

- Follow steps 1 through 4 from 'To Start Cooking Now' on page 21.
- Press the STOP TIME pushbutton once.
- Press the + pushbutton until the time of day **you** want the oven to turn off appears.
 - After 6 seconds, the words DELAY BAKE or DELAY CONV and STOP TIME appear below the Time-of-Day display.
 - The words DELAY BAKE or DELAY CONV appear below the temperature setting, the STOP TIME appears in the window and the programming is complete.

To Cancel A Delayed Auto Cook Bake or Convection Program

- Press the CANCEL pushbutton once.
 - Only the Time of Day remains in the window if the TIMER is not in use.

To check the Time of Day during an Auto Cook program

- Press the CLOCK pushbutton once.
 - The Time of Day will display for 6 seconds, then the STOP TIME will appear.

To change a BAKE or CONVECTION Auto cook Program, see page 23.

SETTING THE OVEN



TO CHANGE A BAKE OR CONVECTION AUTO COOK PROGRAM (with or without delay start)

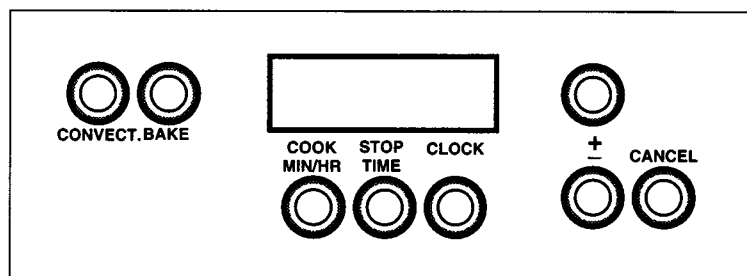

To Change the Oven Temperature

1. Press the BAKE or CONVECT. (convection) pushbutton once.
2. Press the + or - pushbutton until the desired temperature appears.
 - The oven will now reach and maintain the new temperature.

To Change the Stop Time (Delay Auto Cook Only)

1. Press the STOP TIME pushbutton once.
2. Press the + or - pushbutton until the new time for the oven to turn off appears.
 - The oven will now turn off at the new time.

To Change the Cook Time

1. Press the COOK MIN/HR pushbutton once.
2. Press the + or - pushbutton until the new cooking time appears.
 - The oven will now cook for the new set time.

NOTES:

1. If any baking information is still required, the necessary function word will begin to flash after a 6 second delay. If no information is entered, the mode will automatically cancel after 16 seconds.
2. STOP TIME and COOK TIME can be set in 5 minute increments.
3. A maximum COOK TIME of 11 hours 59 minutes can be set in a delayed start program.
4. Press the CLOCK pushbutton once to check the Time of Day. It will display for 6 seconds.



OVEN RACKS

OVEN RACKS

Slow Cooking/Holding Foods

Your range comes with three racks.

Safety Stops:

- The racks are designed with safety stops so that when they are placed correctly on the supports, they will stop before coming completely out from the oven; and will not tilt when placing food on them.
- When placing food on a rack, pull the rack out to the stop position. Place the food on the rack, then slide the rack back into the oven. This will eliminate reaching into a hot oven.

Self-Cleaning

The racks may be cleaned in the oven during the self-clean cycle, **however they will lose their shiny finish and change to a metallic gray.**

See the Range Cleaning Chart for proper care, pages 40 and 41.

Rack Positions

The correct rack position for baking a food item depends on the recipe and the cooking mode, see Cooking Charts pages 29 to 36. The racks are numbered from the bottom to the top of the oven, like an elevator. Rack position 2 is the most frequently used position for baking or roasting; rack position 4 is the most frequently used for broiling. Place rack(s) in the proper position before turning the oven on.

Insert the racks as follows:

1. Hold the rack with the back rail towards the back of the oven. Rest the rear of the rack on the desired rack slide.
2. Push the rack into the oven as far as it will go. It will "drop" into position.
3. Pull the rack forward to confirm safety stops are below rack guide.

Remove or reposition the racks as follows:

1. Slide the rack all the way to the back of the oven.
2. Lift the back of the rack up so the safety stops are above the rack slides.
3. Pull the rack forward to remove.

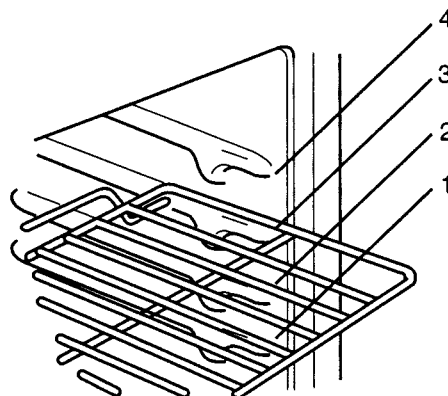

SLOW COOKING AND LOW TEMPERATURE USES OF THE OVEN

The oven can be used at low temperatures to keep hot, cooked foods at serving temperature, to cook foods long and slow (as if using a crock pot), to dehydrate food, to warm plates, and to defrost foods.

Slow cooking of one food or an oven meal is possible by setting the oven to BAKE at a temperature of 225°F.

Food Safety

From the United States Department of Agriculture - DO NOT hold foods at temperatures between 40°F and 140°F for more than 2 hours.

SUGGESTED TEMPERATURE TO KEEP FOOD HOT USING THE BAKE MODE:

170°-200°F		200°-225°F
Biscuits	Pastries	French Fries
Casseroles	Pies	Pancakes
Fish	Pork	Pizza
Muffins	Potatoes	Waffles
Roasts (Med. to Med.-Well)	Seafood	
	Vegetables	

Foods needing to be kept moist must be covered with a lid or aluminum foil.

GENERAL OVEN TIPS

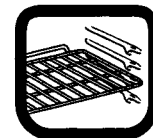

Preheating the Oven

- For best results, preheat the oven when using the BAKE or CONVECTION mode.
- Place racks in the oven before preheating.
- The oven is preheated when the selected temperature is displayed.
- When the oven is preheated, place food in the oven as quickly as possible to prevent heat from escaping.

For Best Results

- Minimize opening the door:
 - Use the (Minute) TIMER.
 - Use the interior oven light to view the food.
- Store the broiler pan or other utensils outside the oven. An extra pan, without food, affects the browning and cooking. Use the Storage Drawer below the oven for convenient storage of the broil pan, cookie sheets, etc. (Models RDF/RDFS/RDSS).
- Use pans that give you the desired browning:
 - For tender, golden brown crusts, use light nonstick/anodized or shiny metal utensils.
 - For brown, crisp crusts, use dark non-stick/anodized or dark, dull metal utensils or glass bakeware.

High Altitude Baking

When baking at high altitudes, in either BAKE or CONVECTION mode, recipes and baking times vary. For accurate information, write the Extension Service, Colorado State University, Fort Collins, Colorado 80521. There may be a cost for the bulletins. Specify the type of information you want (example: cakes, cookies, breads, etc.).

Condensation

It is normal for a certain amount of moisture to evaporate from the food during any cooking process. The amount depends on the moisture content of the food. The moisture will condense on any surface cooler than the inside of the oven. This condensation will quickly evaporate.

Electronic Thermostat

Your new Thermador® range has an electronic thermostat which accurately maintains the temperature selected. Your previous oven may have had a mechanical thermostat that drifted to a higher temperature with age. You may experience an adjustment period using some cooking recipes with your new thermostat. If you feel your oven is baking too hot or too cool, see page 45 to easily calibrate your oven.

CAUTION: Aluminum foil should never be used to cover the oven racks or to line the oven. It may cause damage to the oven if the foil touches the heating element or if heat is trapped underneath it.

ATTENTION: Le papier alu ne doit jamais être utilisé pour couvrir les étagères du four ou de border le four. Il peut causer le dégât au four si le papier alu touche l'élément de chauffage ou si la chaleur est attrapée au dessous de lui.



BAKE TECHNIQUES

BAKE MODE

Baking is cooking with heated air. Both elements in the oven are used to heat the air, but no fan is used to circulate it.

Foods recommended for the bake mode:

Appetizers
Breads
Desserts
Main Dishes
Oven Meals (1 or 2 racks)
Pies, Cakes, Cookies
Poultry
Roasts

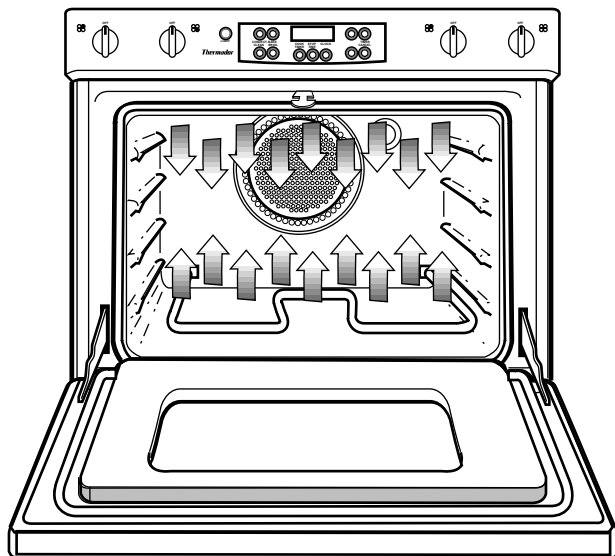

Follow the recipe, convenience food directions, or the following baking charts for the recommended baking temperature, time and rack position. Baking times will vary with the temperature of ingredients and the size, shape and finish of the baking utensil.

General Guidelines

- Use metal bakeware (with or without a nonstick finish), heatproof glass, glass-ceramic, pottery or other utensils suitable for the oven.
- When using heatproof glass, reduce oven temperature 25°F from recommended temperature.
- Use baking sheets with or without sides or jelly roll pans. Maximum size is 12" x 15".
- For best results, bake food on a single rack with at least 1" space between utensils and oven walls.
- Use a maximum of 2 racks when selecting the bake mode. See baking charts for specific rack position on pages 29 to 36.
- Stagger pans or baking sheets so that one is not directly above another.

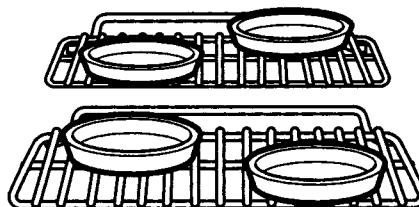

- Check for doneness at the minimum time.

CONVECTION TECHNIQUES



CONVECTION MODE

The heat for convection cooking, whether baking or roasting, comes from both top and bottom elements. This mode uses a fan located at the back of the oven to circulate the heat throughout the oven. This accelerated air movement allows for multiple rack baking and a 25° to 50°F temperature reduction from the standard BAKE setting. **Generally speaking, the longer the cooking time the greater the time savings.**

Foods recommended for the convection mode:

Air leavened foods (souffles, meringue shells, cream puffs, angel food cakes)
 Appetizers (1 to 3 racks)
 Breads
 Main Dishes
 Oven Meals (1 to 2 racks)
 Cookies (1 to 3 racks)
 Pies, Cakes
 Poultry
 Roasts

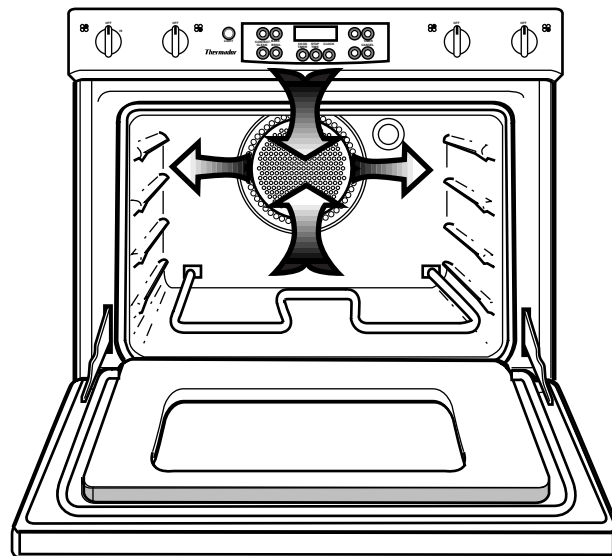

General Guidelines

- Use shiny aluminum pans for best results unless otherwise specified.

NOTE: Dark metal pans and heatproof glass or ceramic can be used. See Bake Techniques on page 26 or General Oven Tips on page 25. Reduce temperature an additional 25°F when using heatproof glass pans for a total reduction of 50°F.

- Use an aluminum baking sheet with only one turned up edge.
- Maximum baking sheet size for multiple rack baking is 12" x 15". Consider using even smaller sheets to improve results.
- Use low sided pans when possible for best air circulation.
- To fully utilize the convection system, cook foods that are uncovered.

- **Multiple rack baking:**
 Cakes and oven meals use racks 1 and 3.
 Cookies, biscuits, rolls, and appetizers use racks 2 and 4 or 2, 3, and 4.

NOTE: 1) When cooking on 3 racks at the same time, food on rack 3 may need a longer baking time than food on 2 and 4.
 2) Pans do not need to be staggered.

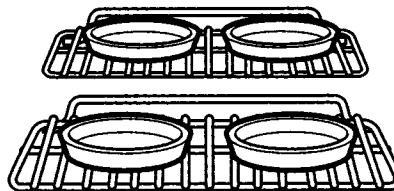

Quick and Easy recipe conversion from standard Bake to Convection: Reduce the temperature 25°F. Use the same cooking time as BAKE if under 15 minutes. If food is cooked over 30 minutes, check 5 to 10 minutes sooner.



BROIL MODE

Broiling is cooking with intense heat radiated from the upper element of the oven. This method sears the outer layer of the food.

Foods recommended for the broil mode:

Appetizers
 Fish Fillets
 Meat (tender, such as steaks, chops, or ground)
 Poultry Pieces
 Top Browning (Breads)

GENERAL GUIDELINES

Rack Positions

Before turning on the oven, place the rack in the desired position. Check the Broil Chart for the best rack position to use for the particular type and thickness of food being broiled. See page 36.

Preheating the Broiler

Preheat the element 2 to 3 minutes for very fast cooking foods such as thin fillets of fish. Preheating is not necessary with denser foods.

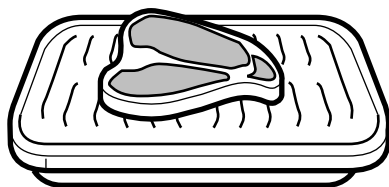

Utensils

- Use the two piece broil pan and grid provided with the oven. The slotted grid allows the meat fat to drip into the lower pan which prevents splattering of fat. **DO NOT** cover the slotted grid (top) with aluminum foil. However, the bottom pan may be lined with foil for easier clean up.
- Clean broil pan and grid after each use. Do not allow grease and fat to accumulate and remain in pan. Flare-ups or fires can occur if grease and fat remain in broil pan. To clean the broil pan, see pages 40-41.
- Do not use other pans for broiling, such as cookie sheets, cake pans, half-sheet pans or jelly roll pans.
- Use metal or glass-ceramic bakeware (Corning™) when top browning casseroles, main dishes, or bread.
- **DO NOT** use heat-proof glass (Pyrexware™) or pottery. This type of glassware cannot withstand the intense heat of the broil element.

BROIL TECHNIQUES

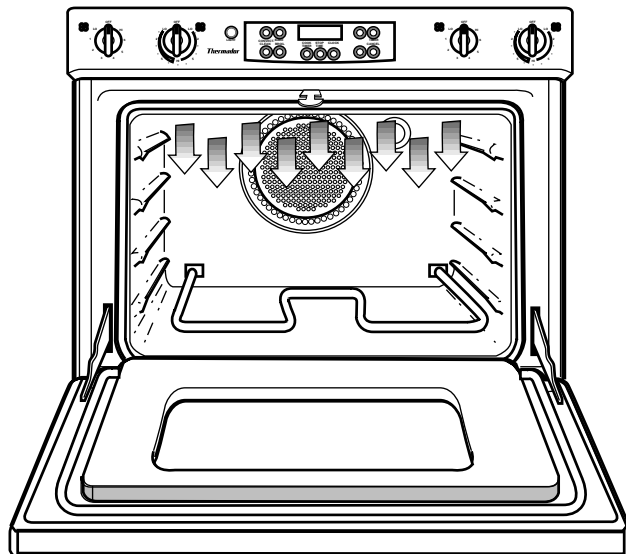

Getting the Best Results

- **Leave the door ajar at the broil stop.** As with all electric ovens, closed door broiling causes the element to cycle off and on which may produce food that tastes roasted/baked (broasted), rather than broiled.
- Most foods need to be turned over only once, after half the total cooking time. Liver slices must be turned over regardless of thickness. Chicken pieces and halves need to be turned over after more than half the total cooking time. Start chicken with skin side down.
- Slash the outside fat around the edges of the meat to keep it from curling.
- Use the (Minute) **TIMER**. Refer to the Broil Chart, page 36 for recommended cooking times.
- Turn on the hood/intake above or at the back of the cooktop during broil.
- If the outside browns too soon, reduce the broil setting. See 'To Change The Broil Setting', Page 20.

BAKING CHARTS

See Convection Techniques, Page 27.



FOOD ITEM	BAKE Temp. (°F) Time	RACK POSITION		CONVECTION Temp. (°F) Time
		Bake	Convection	

QUICK BREADS

Biscuits	PH* 450° 8 to 12 min.		3	PH* 425° 7 to 12 min.
Cornbread	PH 400° 20 to 30 min.		2	PH 375° 20 to 30 min.
Nut Breads	PH 350° 55 to 65 min.		2	PH 325° 50 to 60 min.
Muffins	Follow package directions		2 3	PH 25° lower than package directions
Packaged Refrigerator Rolls	Follow package directions		2 3	PH 25° lower than package directions
Popovers	PH 375° 50 to 55 min.		2	PH 350° 40 to 45 min.

YEAST BREADS

Bread	PH 375° 45 to 60 min.		2	PH 350° 40 to 55 min.
Rolls	PH 375° 15 to 20 min.		2 3	PH 350° 10 to 12 min.
Frozen Dough	PH 375° 20 to 25 min.		2	PH 350° 20 to 25 min.
Pizza With Toppings	PH 450° 15-20 min.		1	PH 425° 15 to 20 min.

*PH = Preheat



BAKING CHARTS

See Convection Techniques, Page 27.

FOOD ITEM	BAKE		RACK POSITION		CONVECTION	
	Temp. (°F)	Time	Bake	Convection	Temp. (°F)	Time

CAKES

Angel Food Mix	PH* 350° 40 to 50 min.	1	PH* 325° 40 to 45 min.
Cake Mix - Non Pudding and Pudding	PH 350° Follow package directions	2 1 & 3	PH 325° Check before minimum bake time
Scratch Cakes	PH 350° 30 to 35 min.	2 3	PH 325° 30 to 35 min.
Cupcakes - Mix	PH 350° Follow package directions	2 3	PH 325° Check before minimum bake time
Specialty Cake Mixes	PH 350° Follow package directions	3	PH 325° Check before minimum bake time

*PH = Preheat

BAKING CHARTS

See Convection Techniques, Page 27.



FOOD ITEM	BAKE		RACK POSITION		CONVECTION	
	Temp. (°F)	Time	Bake	Convection	Temp. (°F)	Time

COOKIES

Brownies	PH* 350° Follow recipe or package directions	2	PH* 25° lower than recipe directions. Check before mini- mum bake time
Drop Cookies	PH 375° 8 to 10 min.	2 & 4 2, 3, 4	PH 350° (See note) 8 to 12 min.
Bar Cookies Mix	PH 375° 20 to 25 min.	2	PH 350° 20 to 25 min.
Refrigerated Doughs	Follow package directions	2 & 4 2, 3, 4	PH 25° lower than package directions

DESSERTS

Fruit Desserts	Follow recipe directions	2	PH 25° lower than recipe. Check before minimum bake time
Bread Pudding	PH 350° 65 to 75 min.	2	PH 325° 50-60 min.
Baked Custard	PH 350° 30 to 35 min.	2	PH 325° 30 to 35 min.
Cream Puffs	PH 400° 35 to 40 min.	2	PH 375° 30 to 35 min.
Meringue Shells	PH 275° 90 min. Turn off oven; leave 60 min.	2	PH 225° 90 min. Turn off oven; leave 90 min.

Note - For convection cookies, there may be cookie doughs (like peanut butter or chocolate chip) that need a 50°F reduction in temperature and a slightly longer baking time.

*PH = Preheat



BAKING CHARTS

See Convection Techniques, Page 27.

For browner, flakier pie crusts:

- Use a glass or dark metal pie pan, or
- Use a shiny aluminum pie pan placed on a small cookie sheet pre-heated with the oven.

FOOD ITEM	BAKE		RACK POSITION		CONVECTION	
	Temp. (°F)	Time	Bake	Convection	Temp. (°F)	Time

PIES

2 Crust Fruit Scratch	PH* 425° 35 to 50 min.**	1	PH* 400° 40 to 50 min.
Frozen	Follow package directions	1	PH 25° lower than package
Custard Type Pumpkin Scratch	PH 425° 15 min., then 350° 45 to 50 min.	1	PH 400° 15 min., then 325° 35 to 40 min.
Frozen	Follow package directions	2	PH 25° lower than package
Meringue (top)	PH 350° 20 to 25 min.	2	PH 325° 20 to 25 min.

PIE CRUSTS

Graham Cracker	PH* 375° 8 to 10 min.	2	PH* 350° 8 to 10 min.
Pastry - Scratch	PH 475° 8 to 10 min.	2 3	PH 425° 10 to 12 min.
Pastry - Refrigerated	PH 450° 9 to 11 min.	2 3	PH 425° 8 to 10 min.
Pastry - Frozen	PH 400° 8 to 11 min.	2	PH 375° 9 to 10 min.

*PH = Preheat

** Scratch pies based on 9" diameter

BAKING CHARTS

See Convection Techniques, Page 27.



FOOD ITEM	BAKE Temp. (°F) Time	RACK POSITION		CONVECTION Temp. (°F) Time
		Bake	Convection	

EGGS / CHEESE

Souffle Cheese	PH* 350° 50 to 50 min.	2	PH* 325° 45 to 55 min.
Strata	PH 300° 90 to 95 min.	2	PH 300° 85 to 90 min.
Quiche	PH 350° 45 to 50 min.	1	PH 325° 35 to 45 min.

FISH

Oven Fried Fish Fillets	PH* 475° 10 to 12 min.	2	PH* 450° 10 to 12 min.
Halibut Steaks 1"thick	PH 350° 30 to 35 min.	2	PH 325° 25 to 30 min.

*PH = Preheat



MEAT ROASTING CHART

FOOD ITEM	BAKE		CONVECTION		DONENESS
	Temp. (°F)	Time	Temp. (°F)	Time	
Beef Standing Rib 4 to 6 pounds	PH* 325° 26 to 32 min. 34 to 38 min. 40 to 42 min.		PH* 300° 23 to 28 min. 28 to 32 min. 32 to 37 min.		Rare - 145° Med. - 160° Well - 170°
Standing Rib 6 to 8 pounds	PH 325° 23 to 25 min. 27 to 30 min. 32 to 35 min.		PH 300° 20 to 24 min. 25 to 29 min. 29 to 33 min.		Rare - 145° Med. - 160° Well - 170°
Rolled Rib 5 to 7 pounds	PH 325° 30 to 34 min. 34 to 38 min. 40 to 48 min.		PH 300° 26 to 28 min. 29 to 31 min. 34 to 36 min.		Rare - 145° Med. - 160° Well - 170°
Boneless Sirloin, Rump, Tri-tip 3 to 6 pounds	PH 325° 25 to 30 min.		PH 300° 30 to 40 min.		145° to 170°
Lamb Leg 5 to 8 pounds	PH 325° 25 to 30 min.		PH 325° 24 to 28 min.		170°
Boneless 3 to 5 pounds	PH 325° 35 to 40 min.		PH 325° 33 to 37 min.		170°
Pork Loin 3 to 5 pounds	PH 350° 26 to 31 min.		PH 325° 30 to 35 min.		170°
Boneless, Picnic Shoulder 3 to 5 pounds	PH 350° 33 to 38 min.		PH 325° 33 to 40 min.		170°
Ham Half (Fully cooked) 5 to 7 pounds	PH 325° 20 to 23 min.		PH 325° 19 to 23 min.		140°
Ham - Canned 3 to 5 pounds	PH 325° 20 to 23 min.		PH 325° 19 to 23 min.		130°
Veal Loin roast (bone in) 3 to 4 pounds	PH 325° 38 to 40 min.		PH 325° 35 to 39 min.		170°
Boneless 2 to 3 pounds	PH 325° 22 to 24 min.		PH 325° 20 to 23 min.		170°

*PH = Preheated

Techniques

- Roast on rack position 2 unless roast is very large; then use rack position 1. Allow approximately 2 inches between the top of the meat and the element.
- Place meat on a roasting rack in a low sided utensil such as the bottom of the broil pan that comes with the oven.
- Use a meat thermometer to cook meat to desired temperature (approximately 5°F less than the desired carving temperature). Insert the thermometer into the center of the thickest part of the roast not touching fat or bone.
- After roasting, allow meat to stand loosely covered with foil for 10 to 15 minutes before carving.
- Meats cooked in cooking bags or covered pans require the same oven temperature and cooking time as used with BAKE.

POULTRY ROASTING CHART



FOOD ITEM	BAKE Temp. (°F) Time	CONVECTION Temp. (°F) Time	DONENESS
Turkey 7 to 14 pounds Unstuffed	PH* 325° 18 to 23 min.	PH* 325° 12 to 16 min.	Thigh - 180° to 185° Breast - 170° Stuffing - 165°
Stuffed	PH 325° 22 to 26 min.	PH 325° 13 to 17 min.	
15 to 22 pounds Unstuffed	PH 325° 14 to 18 min.	PH 300° to 325° 11 to 14 min.	
Stuffed	PH 325° 16 to 22 min.	not recommended	
Turkey Roast Boneless 4 to 6 pounds	PH 350° 22 to 27 min.	PH 350° 22 to 25 min.	170° to 175°
Turkey Breast Whole Boneless 4 to 6 pounds	PH 350° 22 to 29 min.	PH 325° 35 to 38 min.	170° to 175°
Chicken 2-1/2 to 4 lbs. Unstuffed	PH 375° 25 to 30 min.	PH 350° 18 to 21 min.	175° to 185°
Stuffed	PH 375° 27 to 32 min.	PH 350° 19 to 22 min.	175° to 185°
Chicken, Halves 2-1/2 to 4 lbs.	PH 375° 23 to 28 min.	PH 350° 23 to 28 min.	175° to 185°
Chicken Pieces 2 to 3-1/2 lbs.	PH 375° 16 to 19 min.	PH 350° 16 to 19 min.	175° to 185°
Cornish Game Hens Stuffed	PH 375° 75 to 95 min. total time	PH 375° 70 to 90 min. total time	175° to 185°
Unstuffed	PH 375° 60 to 75 min. total time	PH 375° 55 to 70 min. total time	175° to 185°

*PH = Preheated

Techniques

- Roast on rack position 2. For very large turkeys use rack position 1. Allow approximately 2 inches between the top of the bird and the element.
- For juicer breast meat, start breast side down.
- Do not truss the legs of an unstuffed bird.
- Shield ends of legs, wing tips, bony parts of the breast and any thinner parts with foil during the second half of the roasting to prevent over cooking.
- Check for doneness at end of minimum estimated roasting time. Juices will run clear and the drumstick (on whole birds) will move freely when poultry is done.



BROILING CHART

See Broil Techniques, Page 28.

FOOD ITEM	RACK POSITIONS	BROIL SETTINGS	BROIL TIME
Beef Steaks 3/4" to 1"	4	HI	Rare - 7 to 11 min. Med. - 8 to 12 min. Well - 9 to 14 min.
	1-1/4" to 1-1/2"	3	Rare - 16 to 22 min. Med. - 22 to 28 min.
	3	4	Well - 26 to 32 min.
Breads English Muffins Garlic Toast 3/4" to 1"	4	3	4 to 6 min.
Chicken Pieces / Halves	3	LO	Well - 30 to 45 min.
Franks Hot Dogs (Whole) Polish Sausage (cut in half)	4	5	4 to 5 min.
	4	3	7 to 9 min.
Fish 1/2" to 1"	4	4	8 to 12 min.
Ground Beef Patties 3/4" to 1"	4	HI	Rare - 8 to 12 min. Med. - 9 to 14 min. Well - 10 to 15 min.
Ham Steak 1/2" 1"	4	HI	7 to 11 min.
	3	HI	12 to 15 min.
Lamb Chops 1/2" to 1" 1-1/4" to 1-1/2"	4	HI	Med. - 12 to 17 min. Well - 15 to 20 min.
	3	LO	Med. - 21 to 27 min. Well - 27 to 33 min.
Pork Chops 1/2" to 1"	3	HI	Well - 18 to 25 min.

Note: To clean the broil pan, see pages 40-41.

SOLVING BAKING PROBLEMS



With either BAKE or CONVECTION, poor results can occur for many reasons other than a malfunction of the oven. Check the chart below for causes of the most common problems. Since the size, shape and material of baking utensils directly affect the baking results, the best solution may be to replace old baking utensils that have darkened and warped with age. Check the Baking Charts for the correct rack position, pages 29-35.

Baking Problem	Cause
Food browns unevenly	<ul style="list-style-type: none"> • Oven not preheated. • Aluminum foil on oven rack or oven bottom. • Baking utensil too large for recipe. • Pans touching each other or oven walls.
Food too brown on bottom	<ul style="list-style-type: none"> • Oven not preheated. • Using glass, dull or darkened metal pans. • Incorrect rack position. • Pans touching each other or oven walls.
Food dry or has shrunk excessively	<ul style="list-style-type: none"> • Oven temperature too high. • Baking time too long. • Oven door opened frequently.
Food baking or roasting too slowly	<ul style="list-style-type: none"> • Oven temperature too low. • Oven not preheated. • Oven door opened frequently. • Tightly sealed with aluminum foil.
Pies don't brown on bottom or have soggy crust	<ul style="list-style-type: none"> • Using shiny metal pans. • Oven not preheated. • Incorrect rack position.
Cakes pale, flat and may not be done inside	<ul style="list-style-type: none"> • Oven temperature too low. • Incorrect baking time. • Cake tested too soon. • Oven door opened too often.
Cakes high in middle with crack on top	<ul style="list-style-type: none"> • Baking temperature too high. • Baking time too long. • Pans touching each other or oven walls. • Incorrect rack position.
Pie crust edges too brown	<ul style="list-style-type: none"> • Oven temperature too high. • Edges of crust too thin. • Crust edge not shielded with aluminum foil.



SELF-CLEANING THE OVEN

Your new range features a pyrolytic self-cleaning oven. When set into the CLEAN mode, the oven reaches a high temperature that burns off the food soil.

- It is common to see smoke and/or an occasional flame-up during the CLEAN cycle, depending on the content and amount of soil remaining in the oven. If a flame persists, turn off the oven and allow it to cool before opening the door to wipe up the excessive food soil.
- The oven light will not turn on when the oven is set for a clean cycle.

NOTE: Due to the high temperatures used for self-cleaning, the oven may develop fine lines or surface roughness. This is a common condition and does not affect either the cooking or the cleaning performance of the oven.

BEFORE YOU SELF-CLEAN

1. **Hand-clean the oven door edge, window, oven front frame and oven cavity edges (shaded areas below).** They do not get hot enough during the cleaning cycle for soil to burn away. Use a soapy sponge or plastic scrubber or an S.O.S.[®] pad. **Do not rub the gasket.**
2. **Wipe up large overspills and grease with paper towels.**

3. **Remove all utensils.**

4. **Remove oven racks.**

- If the oven racks are left in the oven during a self-cleaning cycle they will permanently lose their shiny finish and change to a dull dark finish. See the Range Cleaning Chart for proper care, pages 40-41.

5. **Be sure the light bulb and glass cover are in place, see page 45.**

6. **Turn on the hood/intake above or at the rear of your range.** Heat and odors are normal during the Self-Cleaning cycle. Keep the kitchen well ventilated.

AFTER SELF-CLEAN

- At the end of the CLEAN cycle, some gray ash may remain inside the oven. The amount of ash depends on how heavily soiled the oven was before it was cleaned. It is easily removed, when the oven is cold, using a damp sponge or cloth.
- If the racks do not slide easily after being cleaned, lightly rub rack side rails with vegetable oil.

IMPORTANT: Be sure to let the glass in the oven door cool completely before wiping up any ash left from the clean cycle.

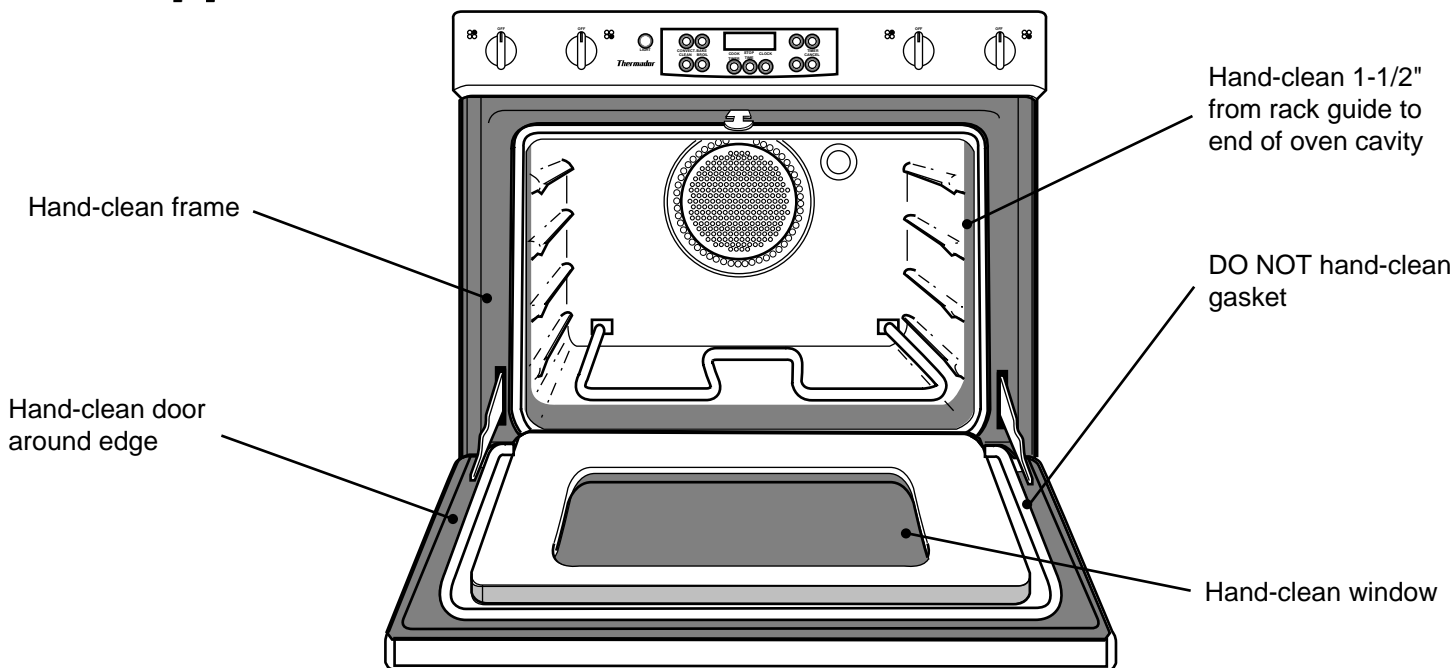

OVEN

SELF-CLEANING THE OVEN

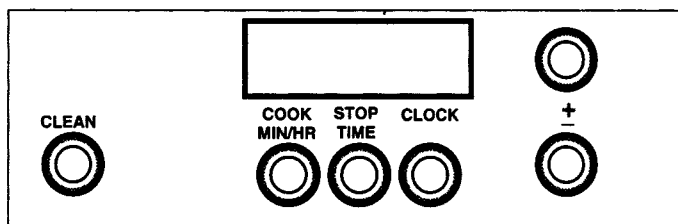

To Start Self-Cleaning Now

1. Follow 'BEFORE YOU SELF-CLEAN', page 38.
2. Close the oven door.
3. Press the CLEAN pushbutton once.
4. Press the + or - pushbutton until the desired length of clean time appears in the window. See notes 1 and 2.
 - After 6 seconds, the word CLEAN and ON appear
 - The clock will count down the cleaning hours.

NOTES:

1. Your oven is preset for a 3-hour Self-Cleaning cycle. However, the cycle time can be adjusted depending upon the amount of soil in your oven. The cycle can be set anywhere between 2 and 4 hours.
2. If the door fails to lock, "door" will be displayed, and the self-clean mode will not function. It will cancel after 1 minute and return to the Time of Day. See 'Solving Operational Problems', page 47.

To Delay the Start of Self-Cleaning

1. Follow steps 1 through 4 of 'To Start Self-Cleaning Now' above.
2. Press the STOP TIME pushbutton once.
 - The preset time the CLEAN operation ends will display.
3. Press the + pushbutton until the time you want the CLEAN operation to end is displayed.
 - After 6 seconds, the words DELAY and DELAY CLEAN appear in the window in addition to the words already displayed.
 - The clock will display the stop time until the oven starts cleaning, then it will display the remaining clean time.

To Change a Clean Program

1. Press the CANCEL pushbutton once.
2. Reprogram Self-Clean cycle.

To Check the Stop Time

1. Press the STOP TIME pushbutton once.
 - The stop time will be displayed for 6 seconds, then the count down of clean time will resume.

To Cancel a Clean Program

1. Press the CANCEL pushbutton once.
 - If the oven "Locked" light is displayed, then the oven temperature is above 500°F, and as a safety precaution, the oven door will not open. When the oven cools below 470°F, the oven will automatically unlock and the "Locked" light will go out. The door may then be opened.

To Check the Time of Day

1. Press the CLOCK pushbutton once to check the Time of Day. It will display for 6 seconds.



RANGE CLEANING

How to use the Range Cleaning Chart

1. Locate the number of the part to be cleaned in the illustration below.
2. Find the part number in the chart.
 - Use the cleaning method in the left column if the range is black or white.
 - Use the cleaning method in the shaded column if the range is stainless steel.
3. Match the letter with the cleaning method on the following page.

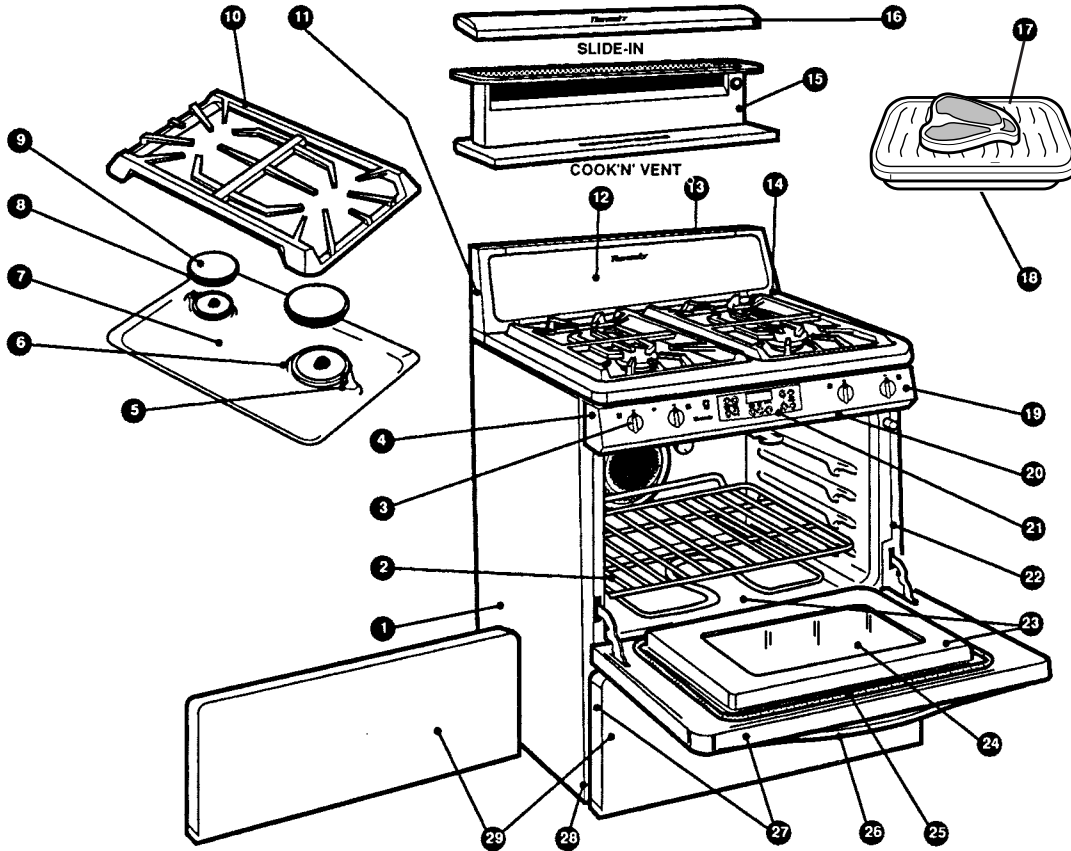

Part	Cleaning Method		Part	Cleaning Method	
	Blk / Wht	Stainless Steel		Blk / Wht	Stainless Steel
① Range Side Panels	G		⑱ Broil Pan (bottom)	I	
② Oven Racks	D		⑲ Control Panel	F	
③ Control Knobs	H	L D H G	⑳ Control Panel Trim	G	I
④ Control Panel End Caps	G		㉑ Control Panel Pushbuttons	H	F G H
⑤ Igniter	C	G	㉒ Oven Front Frame	L	H
⑥ Burner Base	A		㉓ Oven Cavity, Door Interior	I	L I
⑦ Recessed Spillwell/Cooktop	I	C A L	㉔ Oven Door Window Interior	J	I
⑧ Burner Head	A		㉕ Seal (Gasket)	E	J
⑨ Burner Cap	I		㉖ Handle	G	
⑩ Burner Grate	I	A I I G F G K M C	㉗ Oven Door/Storage Drawer Frame	G	E G L
⑪ Backsplash Endcaps	G		㉘ Storage Drawer Interior	G	
⑫ Backsplash	F		㉙ Oven Door/Storage Drawer/Accessory Panel Exterior	F	G
⑬ Backsplash Trim	G				LF
⑭ Backsplash Seal	K				
⑮ Cook'n'Vent®	M				
⑯ Slide-In Back Trim	G				
⑰ Broil Pan Grid (top)	D				

RANGE FINISHES/CLEANING METHOD



The entire range can be safely cleaned with a soapy sponge, rinsed and dried. If stubborn soil remains, follow the recommended cleaning methods below.

- Always use the mildest cleaner that will do the job.
- Rub metal finishes in the direction of the grain.
- Use clean, soft cloths, sponges or paper towels.
- Rinse and thoroughly dry to avoid water marks.

The cleaners recommended below indicate a type and do not constitute an endorsement. Use all products according to package directions.

A	Aluminum Alloy	Use Brillo® or S.O.S.® pads to clean. Rub lightly with grain, rinse and dry. Polish with Revereware Metal Polish®.
B	Anodized Aluminum	Wash with hot sudsy water. Rinse and wipe dry.
C	Ceramic	Gently wipe with a dampened cotton swab or scrape with a toothpick. Avoid excess water on the ignitor.
D	Chrome Plated	Wash with hot sudsy water. Rinse thoroughly and dry. Or, gently rub with Soft Scrub®, Bon-Ami®, Comet®, Ajax®, Brillo® or S.O.S.® pads as directed. Easy Off® or Dow® Oven Cleaners (cold oven formula) can be used, but may cause darkening and discoloration. The broil pan top may be squirted with liquid detergent and covered with wet paper towels. Allow to stand.
E	Fiberglass Knit	DO NOT HAND CLEAN GASKET.
F	Glass	Spray Windex® or Glass Plus® onto a cloth first, then wipe to clean. Use Fantastik® or Formula 409® to remove grease spatters.
G	Painted Surface	Clean with hot sudsy water or apply Fantastik® or Formula 409® first to a clean sponge or paper towel and wipe clean. <u>Avoid using powdered cleansers and steel wool pads.</u>
H	Plastic	Wipe (pushbuttons) or wash (knobs) with soapy sponge. Rinse and dry. Knobs can be removed but should not be soaked. The pushbuttons <u>are not removable.</u>
I	Porcelain Enamel	Immediately wipe up acid spills like fruit juice, milk and tomatoes with a dry towel. Do not use a moistened sponge/towel on hot porcelain. When cool, clean with hot sudsy water; apply Bon-Ami®, Soft Scrub® or a glass ceramic cleaning creme to a damp sponge. Rinse and dry. For stubborn stains, gently use Brillo® or S.O.S.® pads. It is normal for porcelain to craze (hairlike lines) with age due to exposure froheat and food soil.
J	Reflective Glass	BEFORE SELF-CLEANING, clean with soap and a plastic scubber, Brillo® or S.O.S.® pad. Wipe thoroughly with a moistened sponge.
K	Silicone	Clean with a soapy sponge. Rinse and wipe dry.
L	Stainless	Always wipe or rub with grain. Clean with a soapy sponge; rinse and dry. Or, wipe with Fantastik® or Formula 409® sprayed onto a paper towel. Polish with Stainless Steel Magic® and a soft cloth. Remove water spots with a cloth dampened with white vinegar. Use Revereware Instant Stainless Steel Cleaner® to remove heat discoloration. To remove light brown stain (cooked on grease) use a stainless steel cleaner (Kleen King®). Remove burned on grease with Easy Off® Heavy Duty oven cleaner. Put oven cleaner on stainless steel finish ONLY.
M	Cook'n'Vent	See Pages 43 and 44 for cleaning recommendations.



COOK'N'VENT® FEATURES AND OPERATION

Model RDDS only

COOK'N'VENT® FEATURES

The Thermador® Cook'n'Vent® at the back of your range takes the place of an overhead hood and can be conveniently hidden away (lowered) when not in use. Use the Cook'n'Vent® when frying or browning meat, poultry, or fish; cooking pasta, or foods with strong odors, and during a Self-Clean cycle.

For best results:

- The Blower should be operating before starting to cook.
- A higher heat setting may be needed when the Cook'n'Vent® is in operation.

There are four primary parts of the Cook'n'Vent® ventilation system that will be referred to in this manual: the Intake, the Blower, the Blower Speed Control, and the UP/DOWN pushbutton.

The Intake

The Intake, when raised, captures and channels the cooking odors, steam and grease and removes them.

The Blower

The Blower draws the cooking odors, steam and grease into the Intake, passes them through the Intake filters, over the back wall, and moves the exhaust outside the house through the ductwork. The Blower can be attached underneath the range (Built-In Blower) or attached to the roof or outside wall of the house (Remote Blower). Both types of installations are connected to ducting that channels the strong cooking odors out of the kitchen.

UP/DOWN Pushbutton



UP/DOWN
PUSHBUTTON

The Intake UP/DOWN pushbutton is located on the top right of the Intake. Press the UP/DOWN pushbutton once to raise or lower the Intake. **It is not necessary to hold the pushbutton.**

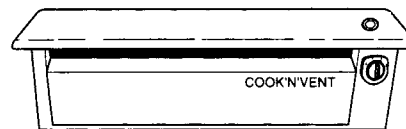

COOK'N'VENT IN RAISED POSITION

Blower Speed Control Knob

The Blower Speed Control Knob is located on the right front of the Intake. The Intake must be raised in order to use the Control Knob.

- There are three Blower speed settings represented by numbers "1"(Low), "2"(Medium), and "3"(High).
- The Blower will be "OFF" when the Control Knob is set to "0".

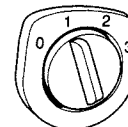

BLOWER SPEED
CONTROL KNOB

Vary the Blower speed as needed for the food or the cooking method being used. For example, cabbage or cauliflower, having strong cooking odors, require more power to capture and remove than is necessary when cooking carrots or corn.

COOK'N'VENT® OPERATION

To Raise the Intake

Press the UP/DOWN pushbutton once to raise the Intake.

- The Intake will stop automatically when it has reached its maximum height.
- If the Blower speed is already set, it will turn on automatically when the Intake is raised.

To Lower the Intake

Press the UP/DOWN pushbutton once to lower the Intake.

- The Blower does not have to be turned off ("0") before the Intake can be lowered. It will turn off automatically when the Intake is lowered.

To Change the Direction of the Intake While It is Moving

Press the UP/DOWN pushbutton once.

- The Intake will stop and move in the opposite direction.

COOK'N'VENT® CARE AND CLEANING

Model RDDS only



COOK'N'VENT® CARE

The efficiency of the Cook'n'Vent® ventilation system depends on the cleanliness of the Intake, especially the filters. The frequency of cleaning depends on the amount and type of cooking. **Clean the Intake front panel and back wall and filters after each use.**

Do not use the ventilating system without the filters in place.

To Clean The Intake

The Intake must be in the raised position to clean.

1. Turn off the Blower Speed Control by setting the knob to "0".
2. **It is not necessary to remove the Intake cover to access the filters.** Grasp the removable front panel at the top near the sides and pull up and forward; remove and set aside.

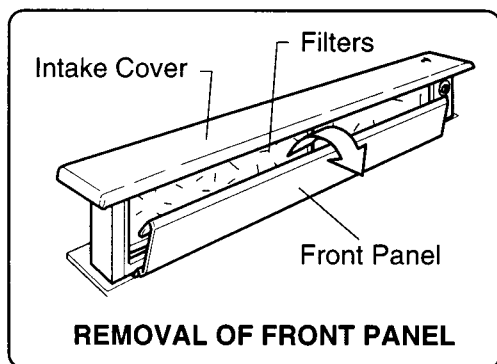

3. Lift out the 2 grease filters. Clean the filters in dishwasher or sink with detergent and hot water. Dry the filters before reinstalling them. Ensure that there is no soil trapped in the fine mesh of the filters.
4. Grease that condenses on the back wall of the Intake can be wiped off with a paper towel or sponge. Heavy grease accumulation may be scraped off with a plastic spatula.
5. Clean the stainless steel front panel and back wall using a mild grease solvent such as Formula 409®. Polish with a stainless steel cleaner/polish. For stubborn soil see cleaning recommendations for stainless steel, page 41.

6. Removing the Intake top or cover can be easily done for cleaning. Simply lift up, while clearing the pushbutton. Wash with hot sudsy water; rinse and dry. Use Formula 409® sprayed onto a paper towel to remove greasy spatters. **Avoid using abrasive powdered cleansers or steel wool pads.**

To Re-Assemble the Intake

The Intake must be in the raised position to re-assemble.

1. Place the filters side by side (there will be some overlap) on the support bars in front of the back panel. The filters will lean backward and the tops will rest against the inside of the back panel.

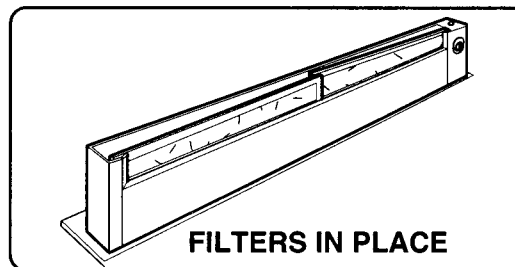

2. Replace the front panel by hooking the lower front edge of the front panel over the front edge of the Intake. (See adjacent illustration).
3. Replace the Intake cover if removed. Be certain pushbutton opening in the Intake cover fits over UP/DOWN pushbutton.

To Clean the Gap between the Intake and the Cooktop.

The Intake must be in the lowered position to clean the gap.

1. Carefully lift off the Intake cover.
2. Clean the gap area using a mild grease solvent such as Formula 409®.
3. Replace the Intake cover as described above.



COOK'N'VENT® CARE AND CLEANING

Model RDDS only

OCCASIONAL COOK'N'VENT® CARE

Approximately every six months, remove any food soil that may have collected behind the Access panel. The frequency of cleaning this area depends on how often the filters and back panel on the Intake are cleaned.

There is an Access Panel to the "clean out" area below the oven door and behind the Accessory panel. See illustration below. The Electrical Connections on the right side of the clean out area must be accessible for electrical inspection or service only. **DO NOT TOUCH OR CLEAN the Electrical Connections.**

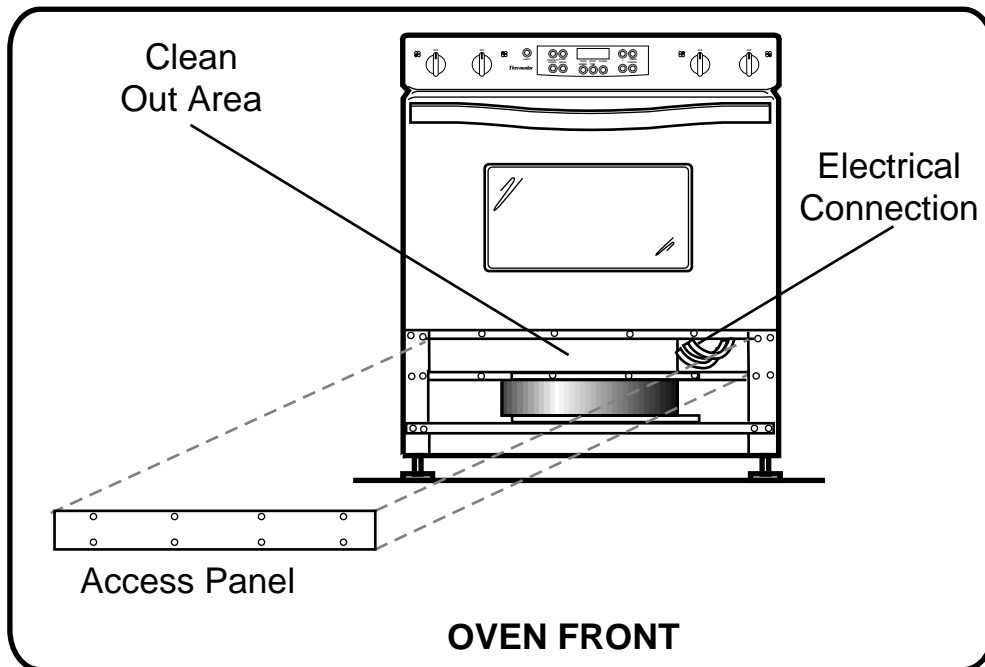

To Reach The Clean Out Area

1. Turn off the circuit breaker or disconnect the fuse to the range before starting to clean.
2. Pull off the lower panel (Accessory Panel) of the range below the oven door. See page 8 and 9 for location.
3. Remove the eight Phillips head screws on the front of the Access Panel. Lift out panel.
4. Avoid the Electrical Connections on the right. Be careful when working around the metal framework of the clean out area as there may be sharp edges.
5. Secure a terry cloth rag to the end of a mop handle with a rubber band. Dampen with hot soapy water or use a general household spray or cleaner. Wipe up any accumulated grease or food around and behind the Blower. Rinse by wiping with a clean damp cloth secured to the end of the mop handle.
6. Replace the Access Panel and tighten the screws securely.
7. Replace the front Accessory Panel.

DO-IT-YOURSELF MAINTENANCE



REPLACING THE OVEN LIGHT

CAUTION: If the light cover is damaged or broken, **do not use the oven** until a new cover is in place.

ATTENTION: Si la couverture d'éclairage est endommagée, ou cassée, **ne pas utiliser le four** jusqu'à une nouvelle couverture est en place.

! WARNINGS:

To prevent electrical shock and/or personal injury:

- Do not operate the oven unless the light cover is securely in position.
- **Before replacing the light bulb, be certain the Automatic Oven Light Switch is depressed or the electric power is turned off.**
- Make certain the oven and light bulb are cool.

! AVERTISSEMENTS:

Pour empêcher le choc électrique et/ou la blessure personnelle:

- Ne pas faire fonctionner le four sauf si la couverture d'éclairage est solidement dans sa place.
- **Avant de remplacer l'ampoule, soyez certain que l'interrupteur D'ÉCLAIRAGE du four (sur le tableau de commande) est dans la position arrête et l'interrupteur d'éclairage automatique sur le cadre du four est déprimé.**
- Soyez certain que le four et l'ampoule sont frais.

The oven light is located at the top of the back wall of the oven. The light has a removable lens cover, a light bulb and a light socket housing that is not removable.

To replace the light bulb, follow these steps:

1. Depress the Automatic Oven Light Switch (See pages 8 and 9 for location) or turn the electrical power off.
2. Unscrew the lens cover counterclockwise.
3. Unscrew the light bulb and replace it with only a **40 watt, 120 volt appliance bulb rated for use in a self-cleaning oven** (available at your local store). **DO NOT USE a standard household light bulb in the oven.**
4. Reinstall the lens cover.

NOTE: If you wash the cover, dry it thoroughly.

5. With the door opened, release the Automatic Oven Light Switch or turn the electric power on to test the light bulb.

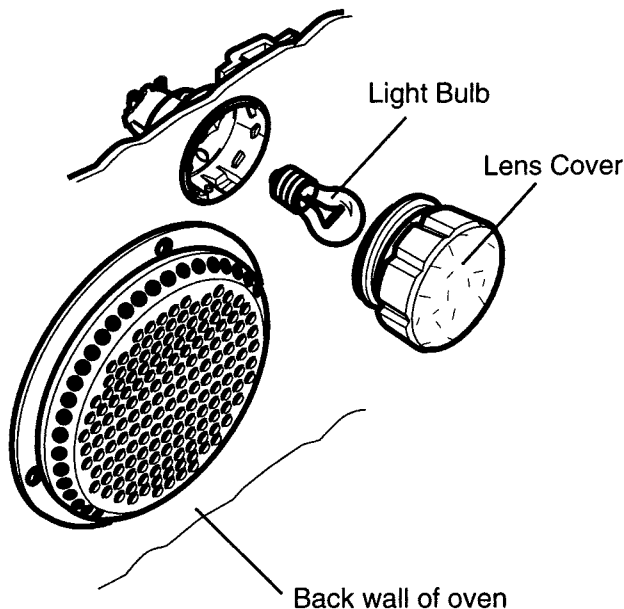

OVEN TEMPERATURE CALIBRATION

Your oven has an electronic thermostat which accurately maintains the selected temperature. However, if generally foods overbrown or underbrown in the cooking time given in your recipe, you have the option to recalibrate the oven.

1. Press the BAKE pushbutton once.
2. Press the + pushbutton until a temperature above 500°F is shown.
3. Immediately, press and hold the BAKE pushbutton for 3 to 4 seconds.
 - The current calibration value is displayed. Standard calibration is "0".
4. For a HOTTER oven due to underbrowning: Press the + pushbutton to raise the temperature from +5° to +35° in 5° increments.
For a COOLER oven due to overbrowning: Press the - pushbutton to lower the temperature from -5° to -35° in 5° increments.
5. Press the CANCEL pushbutton once to enter this new temperature calibration and to return to the regular display (Time of Day).

NOTE: This calibration affects both the BAKE and the CONVECTION temperatures. The calibration is not erased in a power loss.



DO-IT-YOURSELF MAINTENANCE

REMOVING THE OVEN DOOR

The oven door can be lifted off for your convenience in cleaning hard to reach areas.

- Use caution when removing the door as it is very heavy.
- Utiliser l'attention en enlevant la port parce qu'elle est très lourde.

To Remove the Oven Door

1. Fully open the oven door.
2. Raise the U-clip over the hook on each of the hinges to the "locked" position (see illustration below). This will prevent the hinge from snapping closed when the door is removed.
3. Grasp the door by the sides toward the back. Raise the front of the door several inches (there will be some spring resistance to overcome because of the hinge being locked). When the front of the door is high enough, you will be able to lift the hinges to clear the indents.
4. Pull the hinges out of the slots in the oven front frame.

To Replace the Oven Door

1. Grasp the sides of the door at the center and insert the ends of the hinges into the slots in the oven front frame as far as they will go (see illustration below).
2. With the door open all the way, lower the two locking clips.
3. Raise the oven door and make sure that it fits evenly with the front sides.

! WARNING:
 With the door off, never release the levers and try to close the hinges. Without the weight of the door, the powerful springs will snap the hinges closed with great force.

! AVERTISSEMENT:
 Avec la porte enlevée, ne jamais délivrer les leviers et essayer de fermer les charnières. Sans le poids de la porte, les ressorts puissants casseront les charnières fermées avec une grande force.

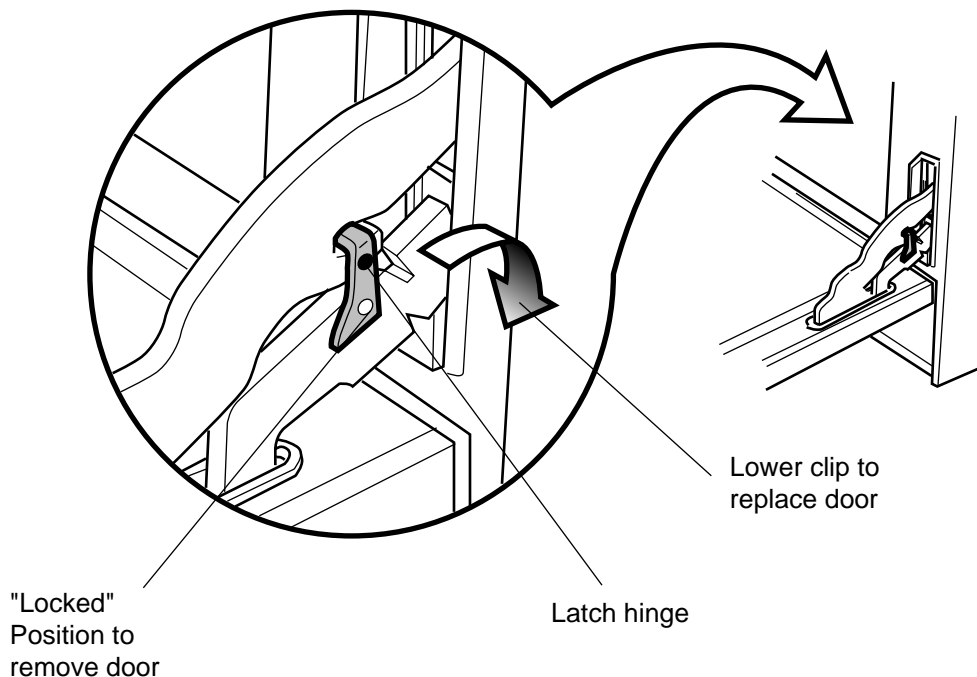

DOOR HINGE

SOLVING OPERATIONAL PROBLEMS



Before calling for service, check the following to avoid unnecessary service charges.

PROBLEM OVEN	PROBLEM SOLVING STEPS
F- 1 or F-3 flash in the display	Check pushbuttons to see if any are stuck. Press CANCEL or turn power off to reset control. If condition persists, call an authorized servicer.
The clock and timer do not work	Make sure there is proper electrical power to the range. See the CLOCK and TIMER sections on Page 18.
The oven will not work	Make sure there is proper electrical power to the range. Check the circuit breaker or fuse box in your house. Reset the oven controls.
The oven light does not work	Tighten or replace the light bulb if loose or defective. If the pushbutton operating the oven light is broken, call an authorized servicer. Oven light does not work in self-clean.
The oven temperature is too hot or too cold	The oven thermostat needs adjustment. See the OVEN TEMPERATURE CALIBRATION in Do-It-Yourself Maintenance: Page 45.
The oven will not self clean	The oven temperature is too high to set the self-clean operation. Allow the range to cool to room temperature and reset the controls. Be sure the oven control is set for CLEAN.
The oven door will not unlock	Allow the oven to cool below the locking temperature.
The oven is not clean after the clean cycle	Heavily soiled ovens may need to self-clean again or for a longer period of time. Heavy spillovers should be cleaned before starting the clean cycle. See Self-Cleaning the Oven, Page 38.
"Locked" light in control but door not locked	Press BAKE pushbutton. "Locked" light will disappear within 20 seconds.
COOKTOP	
The burners do not light within 4 seconds. (Please see COOKTOP OPERATION, Pages 13 and 14.	Make sure the gas shutoff valve is in the ON position and the gas supply to the house is not shut off. The igniter may be wet. Allow to dry. Make sure the burner cap is properly positioned. Check to see that the burner ports are not clogged.
The igniters spark intermittently	Make sure there is no draft in the room.
The burner flame is yellow or distorted	Make sure that the burner cap is level and positioned properly, see Page 13. Check to see if the burner ports are dirty or clogged. See Flame Characteristics, Page 14.
Igniter sparks continuously after flame ignition	If the igniters are wet or dirty, allow them to dry. See the RANGE CLEANING CHART, Page 40. Check the power supply. It should be properly grounded with the polarity correct. Call an authorized servicer.
COOK'N'VENT®	
The blower at the back of the range does not work.	Check that the intake is fully raised. Make sure there is proper electrical power to the range. Make sure speed control is not in the OFF position, "O".

HOW TO OBTAIN SERVICE

For authorized service or parts information, phone 1-800-735-4328

We want you to remain a satisfied customer. If a problem does come up that cannot be resolved to your satisfaction, please let us know. Write: Customer Support, Thermador®, 5551 McFadden, Huntington Beach, CA 92649 or phone 1-800-735-4328.

Please include the Model Number, Serial Number and Date of Original Purchase/Installation.



WARRANTY

THERMADOR® RANGE WARRANTY

RDF30 / RDFS30 / RDSS30 / RDDS30V

WHAT IS COVERED

Full One Year Warranty

For one year from the date of installation, or date of occupancy for a new, previously unoccupied dwelling, any part which fails in normal home use will be repaired or replaced free of charge. Save your dated receipt or other evidence of the installation/occupancy date. Thermador® will pay for all repair, labor, and replacement parts found to be defective due to materials and workmanship. Service must be provided by a Factory Authorized Service Agency during normal working hours.

WHAT IS NOT COVERED

1. Service by an unauthorized agency. Damage or repairs due to service by an unauthorized agency or the use of unauthorized parts.
2. Service visits to:
 - Teach you how to use the appliance.
 - Correct the installation. You are responsible for providing electrical wiring and/or gas installation and other connecting facilities.
 - Reset circuit breakers or replace home fuses.
3. Damage resulting from accident, alteration, misuse, abuse, improper installation or installation not in accordance with local electrical codes or plumbing codes, or improper storage of the appliance.
4. Repairs due to other than normal home use.

WARRANTY APPLICATION

This warranty applies to appliances used in normal family households; it does not cover their use in commercial situations.

This warranty is for products purchased and retained in the 50 states of the U.S.A., the District of Columbia and Canada. The warranty applies even if you should move during the warranty period. Should the appliance be sold by the original purchaser during the warranty period, the new owner continues to be protected until the expiration date of the original purchaser's warranty period.

THERMADOR® DOES NOT ASSUME ANY RESPONSIBILITY FOR INCIDENTAL OR CONSEQUENTIAL DAMAGES. Some states do not allow the exclusion or limitation of incidental or consequential damages, so the above limitation or exclusion may not apply to you. This warranty gives you specific legal rights and you may also have other rights which may vary from state to state or province to province.

SERVICE DATA

For handy reference, copy the information to the right from the data/serial tag (See page 8 for location). Keep your invoice for warranty validation.

To obtain service, see page 47.

Model Number
Serial Number
Date of Installation or Occupancy

Specifications are for planning purposes only. Refer to installation instructions and consult your countertop supplier prior to making counter opening. Consult with a heating and ventilating engineer for your specific ventilation requirements. We reserve the right to change specifications or design without notice. Some models are certified for use in Canada. Thermador is not responsible for products which are transported from the U.S. for use in Canada. Check with your local Canadian distributor or dealer.

For the most up-to-date critical installation dimensions by fax, use your fax handset and call (702) 833-3600. Use code #8030.

Thermador[®]

5551 McFadden Avenue, Huntington Beach, CA 92649 • 800/735-4328
ECO 14062 • 5020005577 • 14-33-870G • © 2002 BSH Home Appliances Corp. • Litho in USA 11/02